

Cole-Parmer®

SP-500-VIS
SP-500-UV
SP-600-UV

Spectrophotometer



Instruction Manual
JEN0001-CPB Version 1.4

Cole-Parmer®

Contents

Section 1 - Introduction	6
1.1 General Description.....	6
1.2 Important Safety Advice.....	6
1.3 Symbols Defined.....	6
1.4 Electrical Requirements.....	7
Section 2 - Installation.....	8
2.1 Unpacking.....	8
2.2 Installation Conditions.....	8
2.3 Overview.....	9
Section 3 - Theory and Practice of Spectroscopy Measurement.....	10
3.1 Theory of Spectroscopy Measurement.....	10
3.2 Spectroscopy Measurement.....	11
3.3 Good Practice Guidelines.....	12
Section 4 - Instrument Set up.....	14
4.1 Start up Screen.....	14
4.2 Navigation.....	14
4.3 Methods.....	16
4.4 Results.....	16
4.5 Settings.....	16
4.5.1 Instrument Status.....	16
4.5.1.1 Instrument Language.....	16
4.5.1.2 Setting the Time.....	17
4.5.1.3 Setting the Date.....	17
4.5.1.4 Setting the Time Zone=	18
4.5.2 Measurement Settings.....	18
4.5.3 Network Connections.....	19
4.5.4 Storage.....	19
4.5.5 Service Settings.....	19
Section 5 - Photometrics.....	20
5.1 Method Set up.....	20
5.1.1 Selecting a Wavelength.....	20
5.2 Calibration.....	21
5.3 Sample Measurement.....	21
Section 6 - Concentration.....	22
6.1 Method Set up.....	22
6.1.1 Selecting a Wavelength.....	22

6.1.2	Using a Factor.....	22
6.1.3	Using a Standard	23
6.1.4	Selecting Concentration Units.....	23
6.2	Calibration.....	23
6.2.1	Calibrating to a Factor	24
6.2.2	Calibrating to a Standard	24
6.3	Sample Measurement.....	25
6.3.1	Measuring a Sample After Calibrating to a Factor.....	25
6.3.2	Measuring a Sample After Calibrating to a Standard	25
Section 7 - Spectrum		26
7.1	Method Set up.....	26
7.1.1	Setting Start and End Wavelengths.....	26
7.1.2	Setting the Scan Interval	27
7.1.3	Selecting Absorbance or % Transmittance.....	27
7.2	Calibration.....	27
7.3	Sample Measurement.....	27
7.4	Data Analysis.....	28
7.4.1	Peaks and Valleys.....	28
7.4.2	Area Under Curve	29
7.4.2.1	Area Under Curve - Baseline Mode	29
7.4.2.2	Area Under Curve - Tangent Mode.....	30
Section 8 - Quantitation		31
8.1	Method Set up.....	31
8.1.1	Selecting a Wavelength	31
8.1.2	Selecting Number of Replicates	32
8.1.3	Selecting Concentration Units.....	32
8.2	Measuring Calibration Standards	33
8.3	Standard Curve.....	34
8.4	Sample Measurement.....	35
Section 9 - Kinetics.....		36
9.1	Method Set up.....	36
9.1.1	Selecting a Wavelength	36
9.1.2	Setting the Kinetics Measurement Time	37
9.1.3	Setting the Measurement Time Interval	37
9.1.4	Setting Lag Time.....	37
9.1.5	Selecting Absorbance or % Transmittance.....	37
9.1.6	End Point Concentration	37
9.2	Calibration.....	38

9.3	Sample Measurement.....	38
9.4	Data Analysis.....	40
Section 10 - Multi-Wavelength.....		41
10.1	Method Set up.....	41
10.1.1	Selecting a Wavelength	41
10.1.2	Equation Parameters	42
10.1.2.1	Entering a Factor.....	43
10.1.2.2	Selecting Concentration Units.....	43
10.1.3	Selecting Absorbance or % Transmittance.....	43
10.2	Calibration.....	44
10.3	Sample Measurement.....	44
Section 11 - Saving, Loading, Deleting and Printing.....		45
11.1	Saving Methods	45
11.1.1	Saving Methods to Internal Memory	45
11.1.2	Saving Methods to USB Memory Stick.....	45
11.2	Loading Methods	45
11.2.1	Loading Methods from Internal Memory.....	45
11.2.2	Loading Methods from USB Memory Stick	45
11.3	Deleting Methods.....	45
11.4	Saving Results	46
11.4.1	Saving Results to Internal Memory	46
11.4.2	Saving Results to USB Memory Stick.....	46
11.5	Loading Results	46
11.5.1	Loading Results from Internal Memory	46
11.5.2	Loading Results from USB Memory Stick	46
11.6	Deleting Results.....	46
11.7	Printing	46
Section 12 - Accessories and Spare Parts		47
12.1	Optional Accessories	47
12.2	Installing the Accessories	47
12.2.1	Passive Accessories	47
12.2.2	Active Accessories.....	48
12.2.2.1	Installing Automatic 8 Cell Turret.....	49
12.3	Using the Accessories.....	50
12.3.1	Automatic 8 Cell Turret.....	50
12.3.1.1	Automatic 8 Cell Turret - Manual Mode	50
12.3.1.2	Automatic 8 Cell Turret - Automatic Mode	52
12.3.1.3	Automatic 8 Cell Turret - Supporting Creation of a Standard Curve in Quantitation	54

12.4	Spare Parts.....	54
Section 13	- Maintenance, Servicing and Cleaning	55
13.1	Routine Maintenance.....	55
13.2	Lamp Replacement	57
13.2.1	Tungsten Halogen Lamp Replacement	57
13.2.2	Xenon Lamp Module Replacement.....	58
13.3	Service, Repairs and Support	58
13.4	Warranty.....	58
Section 14	- Environmental Protection	58
14.1	Packaging Material	58
14.2	Waste Electrical and Electronic Equipment Directive (WEEE)	58
Section 15	- Technical Specification.....	59
15.1	General Specification.....	59
15.2	Weights and Dimensions	60
Section 16	- Troubleshooting	61
Section 17	- Glossary of Icons.....	63
Index	64
Declaration of Conformity	67

Section 1 - Introduction

Thank you for purchasing this Cole-Parmer product. To get the best performance from the equipment, and for your own safety, please read these instructions carefully before use.

If the equipment is not used in the manner described in this manual and with accessories other than those recommended by the manufacturer, the protection provided may be impaired.

1.1 General Description

The SP-500-VIS, SP-500-UV and SP-600-UV spectrophotometers are suited to a wide range of applications in education, quality control, environmental and clinical analysis. The SP-500-VIS is a visible spectrophotometer covering a wavelength range from 320nm to 1000nm. The SP-500-UV and SP-600-UV are UV/Visible spectrophotometers with a wavelength range from 198nm to 1000nm. All models have measurement modes for Photometrics, Concentration, Spectrum scanning, Multi-wavelength, Quantitation and Kinetics.

Note: CPLive is no longer supported on SP-500 and SP-600 Series models.

1.2 Important Safety Advice

Users should be aware of the following safety advice:

- SHOCK HAZARDS OR UNSAFE PRACTICES ARE DANGEROUS as they can cause severe personal injury, fire or death.
- DO NOT use combustible substances near hot objects.
- DO NOT use the equipment in hazardous atmospheres.
- DO NOT operate or handle any part of the equipment with wet hands or use on surfaces that may become flooded.
- NEVER move the equipment while still connected to the power supply.
- HIGH TEMPERATURES ARE DANGEROUS as they can cause serious burns to operators and ignite combustible material.
- USE CARE AND WEAR PROTECTIVE GLOVES TO PROTECT HANDS.
- NEVER lift or carry the equipment during operation.
- DO NOT position the equipment unit so that it is difficult to disconnect from the mains supply using the mains plug.
- The mains outlet socket used should be located close to the equipment and readily identifiable and accessible to users.
- DO NOT leave equipment switched on and it is not recommended to leave any heating apparatus unattended during operation.
- The equipment should be carried using both hands.

1.3 Symbols Defined



1.4 Electrical Requirements



THIS INSTRUMENT MUST BE GROUNDED

Before connection please ensure that the line supply corresponds to the power requirements below:

Power	Supply requirements
65 W	100 V - 230 V ~ 50/60 Hz

The equipment is provided with a power supply unit and three power cables consisting of a UK 3-pin and a "Schuko" 2-pin plug for 230 V installations and a NEMA 5-15 plug for 120 V installations.

Choose the power cable appropriate for your electrical installation and discard the others. Should one of the power cables be suitable for connecting to the power supply, replace the plug with a suitable alternative..

THIS OPERATION SHOULD ONLY BE UNDERTAKEN BY A QUALIFIED ELECTRICIAN.

NOTE: Refer to the equipment rating plate to ensure that the plug and fusing are suitable for the voltage and wattage stated. The wires in the mains cable are as follows:

230 V a.c.	120 V a.c.	
HOT/LIVE - BROWN	BLACK - HOT/LIVE	
NEUTRAL - BLUE		WHITE - NEUTRAL
EARTH - GREEN/YELLOW	GREEN - EARTH	

The appropriate power cable and power adaptor combination should be connected to the equipment BEFORE connection to the mains supply. Should the mains lead require replacement, a cable of 1.25mm² (AWG16) of harmonised code H05VV-F connected to an IEC320 plug should be used.



IF IN DOUBT CONSULT A QUALIFIED ELECTRICIAN

Section 2 - Installation

2.1 Unpacking

Before discarding the packaging check that all parts are present and correct.

① SP-500-VIS / SP-500-UV /
SP-600-UV

② Instruction manual

③ UK power lead

④ EU power lead

⑤ US power lead

⑥ Power supply unit

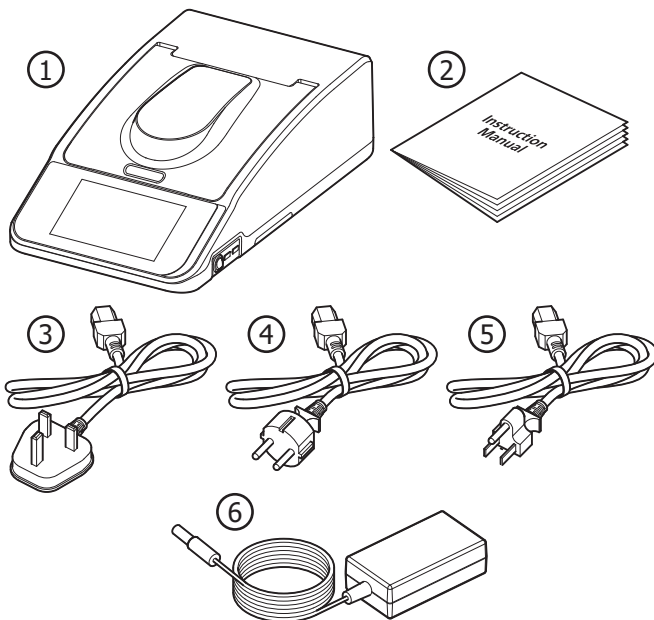

2.2 Installation Conditions

i When the equipment is used for the first time or moved to a different environmental temperature, it is important to allow the equipment to equalise to the ambient temperature. We recommend you allow the equipment to stand for 2 hours before switching on.

This equipment is designed to operate safely under the following conditions:

- For indoor use only
- Use in a well ventilated area
- Ambient temperature range 5°C to 40°C (41°F to 104°F)*
- Altitude to 2000m (6500 ft)
- Relative humidity not exceeding 80% (temperature 31°C) decreasing to 50% (temperature 40°C) and free from condensation
- Mains supply fluctuations not exceeding 10% of nominal
- Overvoltage category
- Pollution degree 2
- Use with a minimum distance all round of 300mm (12in.) from walls or other items

Place the equipment on a clean, firm, level surface which is free from drafts. Avoid installation on a slippery surface or on a surface prone to vibration or on a surface prone to flooding.

Select the power lead and attach to the power supply unit. Connect the power supply unit to the power inlet socket on the rear panel of the instrument and connect to the mains socket. Ensure that the sample chamber is empty before turning the power on at the mains and switching the instrument on using the power switch on the side of the instrument.

The equipment will perform several power-on tests and wavelength calibration before displaying the main screen.

NOTE: SP-500-VIS must be switched on 30 minutes before any readings are performed to allow the tungsten lamp to warm up

NOTE: Leaving cuvettes in the sample holder during power up will result in failure of the power on tests.

2.3 Overview

Main View

- ① Lid
- ② Open and close catch
- ③ Colour touchscreen and user interface
- ④ Removable panel for sipper accessory
- ⑤ 2 x USB Type A ports
- ⑥ On/Off power switch

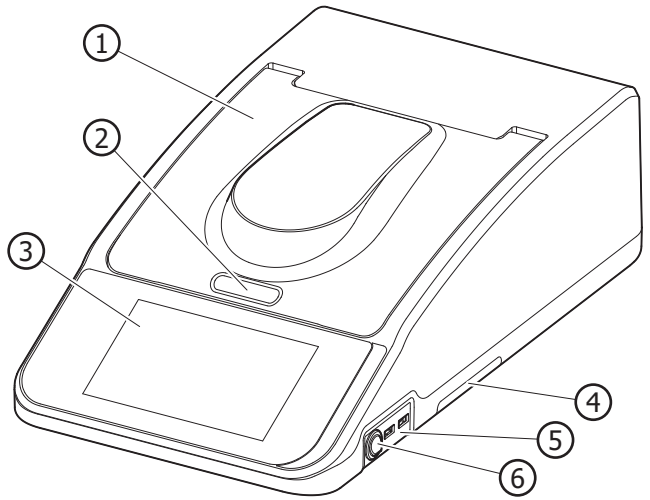

Rear View

- ⑦ Ethernet (RJ-45) port
- ⑧ USB Type B port
- ⑨ Power inlet socket

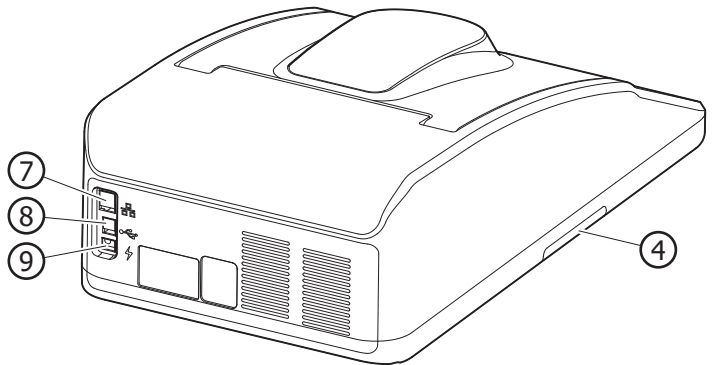

Underneath View

- ⑩ Lamp holder cover

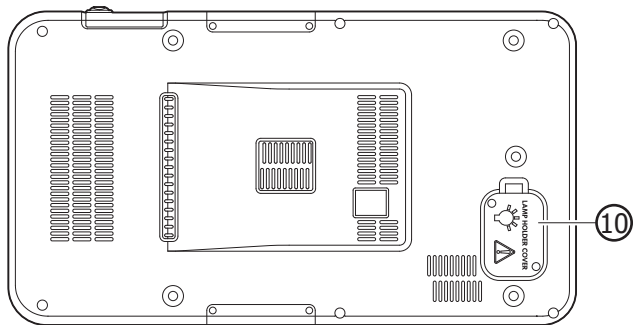

Refer to Section 13.2 for instructions on how to remove and replace the lamp.

Section 3 - Theory and Practice of Spectroscopy Measurement

3.1 Theory of Spectroscopy Measurement

UV-visible spectroscopy is the measurement of the absorbance of light at a specific wavelength in a sample. This is used to identify the presence and concentration of molecular entities within the sample. The Beer-Lambert law is used to relate the absorption of light to the properties of the sample through which the light is travelling through. The Beer-Lambert law states that:

$$A = \epsilon l c$$

- A** is the absorbance
- ϵ** is the molar absorption coefficient ($l \text{ mol}^{-1} \text{cm}^{-1}$)
- l** is the path length (cm)
- c** is the concentration (mol l^{-1})

This law shows that absorbance is linear to concentration but this is only true for low concentrations. For absorbance levels above 3 the concentration starts to move away from the linear relationship.

Transmittance is the proportion of the light which passes through the sample:

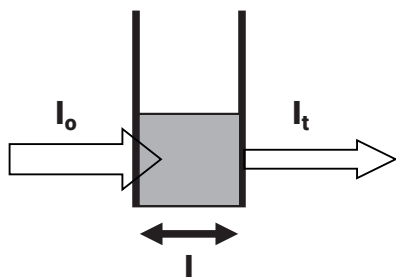

Where:

- I_o is the incident light
- I_t is the transmitted light
- l is the path length

Therefore:

$$T = \frac{I_t}{I_o}$$

Absorbance is inversely related to transmittance:

$$A = \text{Log } \frac{1}{T}$$

3.2 Spectroscopy Measurement

There are four main components of a spectrophotometer. These are a light source to emit a high and constant amount of energy over the full wavelength range; a method for separating the light into discrete wavelengths; a sample holder and a light detector.

The optical layout of the SP-500-VIS and SP-500-UV spectrophotometers is shown below:

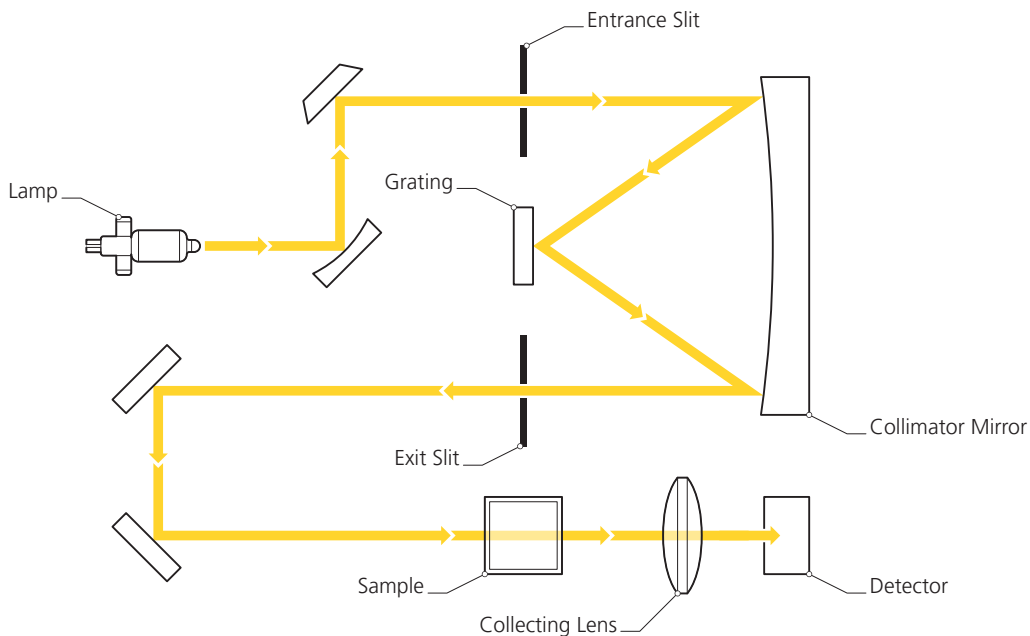

The light from the pre-focused tungsten halogen (SP-500-VIS) or pre-aligned xenon (SP-500-UV) lamp is focused onto the grating, with 1200 lines per millimetre, which separates the light into discrete wavelengths. The diffracted spectrum of light then passes through a further slit and lens arrangement before passing through the sample in the sample chamber from left to right. The light which is not absorbed by the sample is transmitted through a collecting lens and onto the signal detector. The photo-diode detector used is mounted directly onto the detector PCB and the output is used to calculate the % transmittance. The result is displayed either as % transmittance or absorbance on the instrument display.

Note:

On the SP-600-UV model an additional detector at the exit slit detects the incident light and noise through the optical system

3.3 Good Practice Guidelines

1. For optimum performance all spectrophotometers should be sited in a clean, dry, dust free atmosphere. When in use ambient temperature and light levels should remain as constant as possible.
2. If required adherence to Standard Operating Procedures (SOP) and Good Laboratory Practice (GLP) should be monitored with regular calibration checks and a suitable Quality Control (QC) programme.
3. The sample chamber lid must be fully closed during measurement and before any readings are recorded or printed.
4. The correct selection of sample containers is imperative for accurate and reproducible results:
 - a) Check that the material of the sample container is compatible with the wavelengths to be used for measurement. In general glass can only be used down to 360nm or 320nm depending on quality. Standard plastic cuvettes can be used down to 320nm. Special UV versions can be used down to 260nm. Below this level quartz cuvettes must be used.
 - b) Plastic disposable cuvettes should only be used ONCE.
 - c) Glass cuvettes should be thoroughly cleaned after use. Discard when scratches become evident on optical surfaces.
 - d) Care should be taken when selecting semi-micro or micro cuvettes. The cuvette window on the inner chamber (the area filled with sample) must be wider than the aperture in the sample holder or light will reach the detector without passing through the sample. In this case, semi-micro or micro cuvettes with self-screening black surrounds must be used or, alternative holders for these cuvettes should be used.
 - e) Glass test tubes and other sample tubes should be used with care. Where possible, matched tubes should be used and any index mark set to the correct position before measurements are made.
 - f) Ensure any sample containers used are compatible with the constituents of both the samples and standards they are to hold. Plastic cuvettes are not compatible with organic solvents.
 - g) All sample containers must be handled with care; by the top, bottom and non-optical surfaces only. Any finger marks evident must be removed by a suitable cleaning process.
 - h) Flow-through cuvettes must be selected with care and consideration for the sample type, sample volume, pumping system, rinse, sample and waste handling to be used.
5. Samples and standards should not be stored in open cuvettes or sample containers as evaporation will change the value and lead to staining of the walls which may be irreversible. If stored in stoppered and sealed cuvettes, they should be filled with little or no air space and the values regularly checked against a reference standard or quality control material.
6. Samples should be allowed to equilibrate to ambient temperature before measurement (unless a suitable temperature controlled sample holder is in use). Temperature change during measurement may cause air bubbles to form on the walls of the sample holder. This is a common cause of drift during measurement.
7. In the preparation of samples and standards high grade borosilicate glass and AR grade chemicals and reagents must be used. Good quality deionised water or other suitable solvents must be used for dissolving or diluting samples, chemicals and reagents.
8. All measurements require calibration to a blank, for maximum accuracy this should be prepared with care using the same deionised water or solvent used for dissolving or diluting the sample. Where reagents are added to the sample to produce a colour proportional to its concentration a 'sample based' blank should be used. In this case the blank should consist of all reagents or chemicals to be used, except the sample which will produce the colour to be measured.

9. Deviations from the Beer-Lambert Law may occur at high and low concentrations giving non-linear response during sample concentration measurements. For all new methods a linear range should be defined by the preparation of a calibration curve. The quantitation mode may be used to construct such a curve against which sample results are automatically measured.
10. Cuvettes and sample holders must be filled to a minimum level which covers the light path. All Cole-Parmer spectrophotometers have a beam height of 15mm.
11. The instrument must be calibrated to zero absorbance/100% transmittance prior to taking readings. In the spectrum measurement mode a baseline scan must be performed before performing a sample scan.

Section 4 - Instrument Set up

4.1 Start up Screen

The power up screen is shown below:



4.2 Navigation

The main menu is shown below:

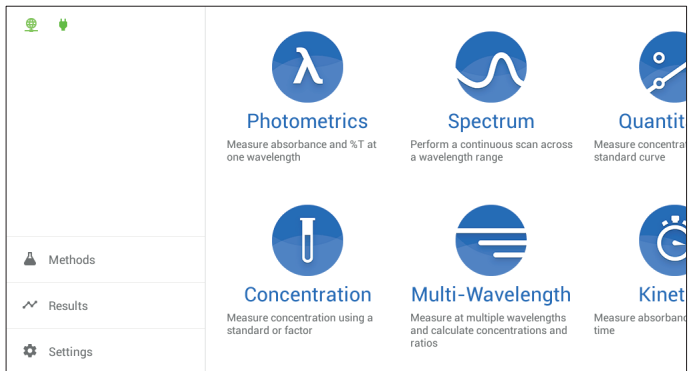



These spectrophotometers are controlled solely through the touchscreen interface of the equipment and follow a basic Android user interface. If the number of options available in a menu exceeds the number that can be displayed on the screen, swipe to the left to view the other modes.

The main menu screen provides access to all Measurement modes, Methods, Results and the Settings menu. Additional icons are displayed when the unit is connected to a network and if an active accessory is installed. The settings menu enables access to Instrument status, Measurement settings, Network connections Storage and Service settings.

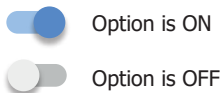
Throughout, the software options can be turned ON and OFF using a switch:



In each measurement mode there is an overflow icon  giving additional save and load method options.

Touching  Load Method gives options to load a previously saved method, touch  Save as Method to save the entered method parameters or touch  Clear Recent to clear recently used method parameters.

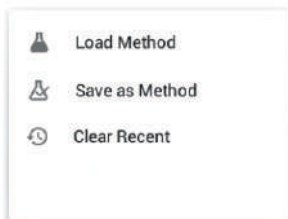

When required to enter numbers, a keypad will pop up. Touch the required numbers and touch **Done** to apply. To exit the keypad without changing the entered value touch **Done** or the minimize icon .



When required to enter letters, a keypad will pop up. Touch the required letters and touch **Save** to apply. To exit the keypad without changing the entered value touch **Save**.

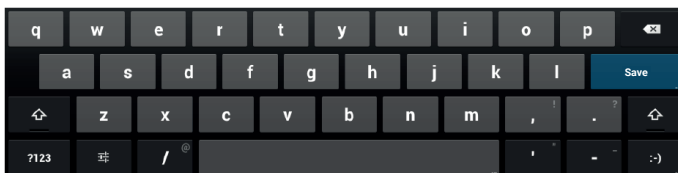

4.3 Methods

Touch  **Methods** to access methods that have been saved. Touch the required method to view the details of the method set up. You will then be able to delete, upload, export, edit or run the selected method. See section 11 for more information.

4.4 Results

Touch  **Results** to access results that have been saved. Touch the required results to view the details of the result. You will then be able to delete, upload or export the selected result. See section 11 for more information.

4.5 Settings

Touch  **Settings** to enable access to instrument status, measurement settings, network connections, storage and service settings.

4.5.1 Instrument Status

Touch  **Instrument status** to view the status of the spectrophotometer, check connections, fitted accessories, the serial number of the unit and the software version the instrument is using. The language and date and time can also be set here.

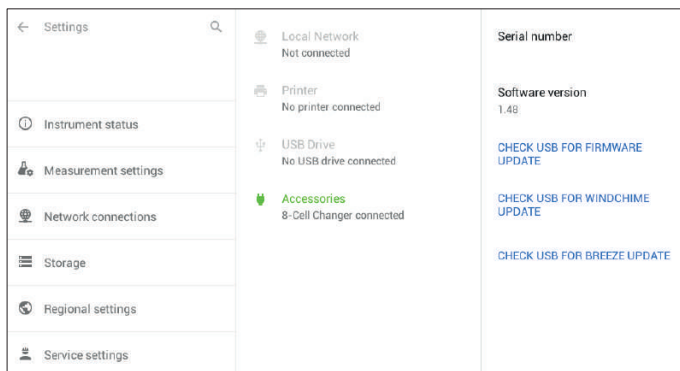

4.5.1.1 Instrument Language

The software can be viewed in five different languages with a choice of English, French, German, Spanish or Italian. To select the required language touch **Language** and select from the menu. Touch  next to the required language to apply.

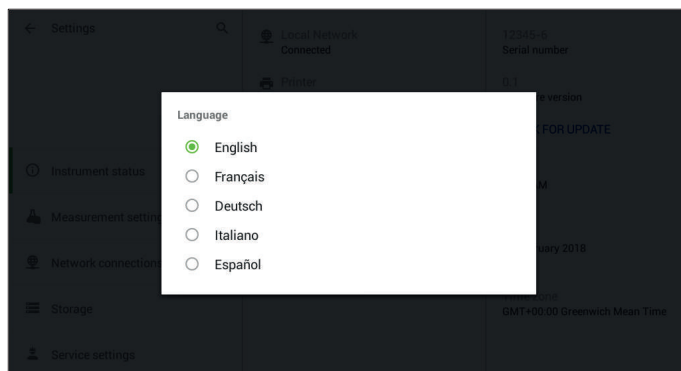

4.5.1.2 Setting the Time

To set the instrument time touch **Time** 11:00 AM Touch **03** and move the clock hand **3** to the correct hour position, repeat the same process for minutes, select AM or PM and touch **OK** to apply. Touching **CANCEL** will return to the instrument settings screen without altering the time. The set time will be displayed in each measurement mode and will be recorded against saved methods and results.

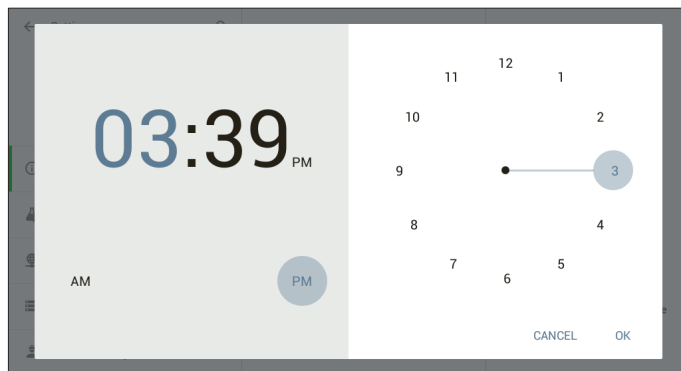

4.5.1.3 Setting the Date

To set the instrument date touch **Date** 26 April 2019 Scroll up or down to change the month viewed. Touch the required date **24** and touch **OK** to apply. To set the year touch **2018** and scroll up or down and touch the required date **2018** and touch **OK** to apply. Touching **CANCEL** will return to the instrument settings screen without altering the date. The set date will be displayed in each measurement mode and will be recorded against

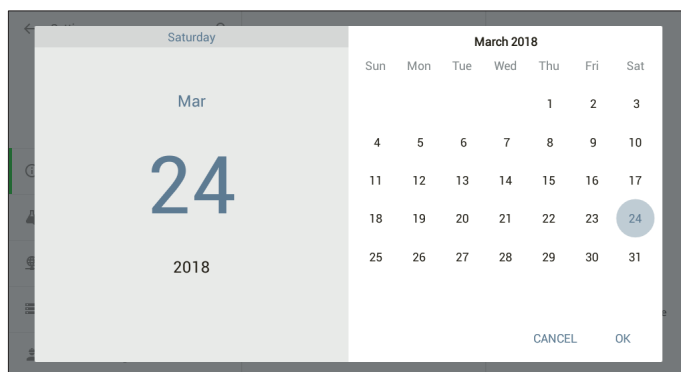



4.5.1.4 Setting the Time Zone

Time zone

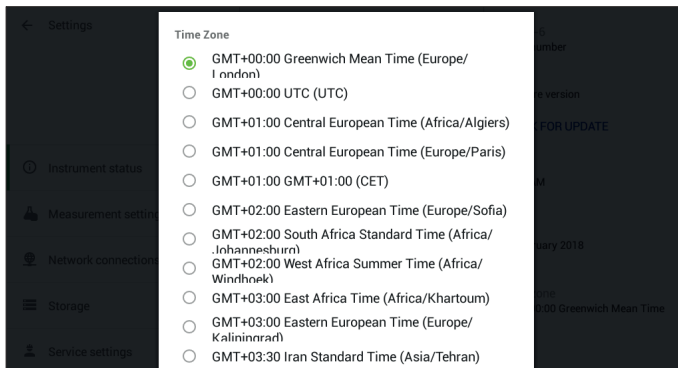
To set the instrument time zone touch **GMT+01:00 British Summer Time** . Scroll up or down to locate the required time zone and touch next to the required time zone to apply.



4.5.2 Measurement Settings

Touch  **Measurement settings** to select options for autosave results and the favourites panel. Results can be saved automatically to the instrument's internal memory by sliding the **Auto-save Results** button to the  position. To view the favourites panel on the home screen slide the **Display favourites panel** button to the  position.

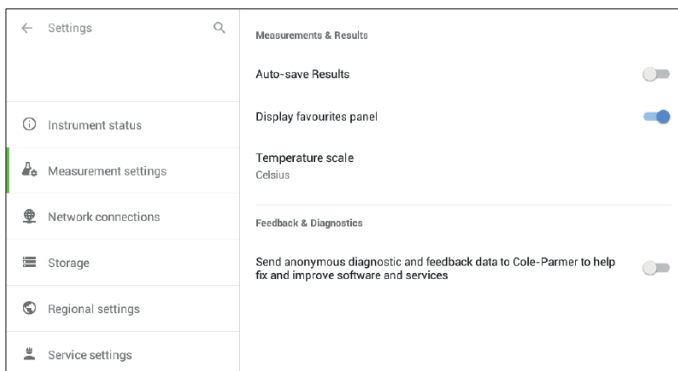

If auto-save is not selected, then results need to be saved manually. Refer to section 11.4 for more details.

4.5.3 Network Connections

Touch  **Storage** to view available network connections. Options include Ethernet (RJ-45), IP configuration, connection status. **Note:** CPLive is no longer supported.

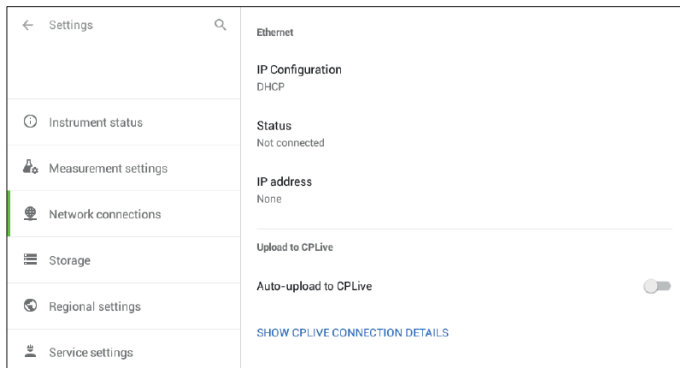

4.5.4 Storage

Touch  **Regional** to view the amount of available storage on the internal memory of the spectrophotometer. If a USB memory stick is inserted the amount of free space on the USB stick will also be shown.

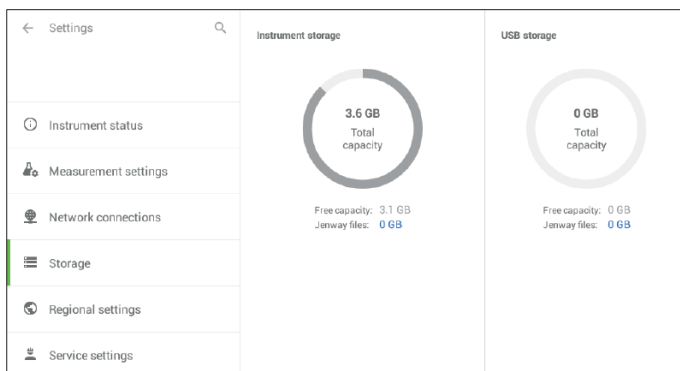

4.5.5 Service Settings

Service settings is for service engineers only

Touch  **Service settings** to view the serial number and options to change serial number and to open windchime.

Section 5 - Photometrics

The photometrics measurement mode enables simple measurements of absorbance and % transmittance to be performed. The sample is measured at one wavelength and at one point in time. There are no post measurement calculations available in this measurement mode. Touch the Photometrics icon on the main menu to enter this measurement mode.

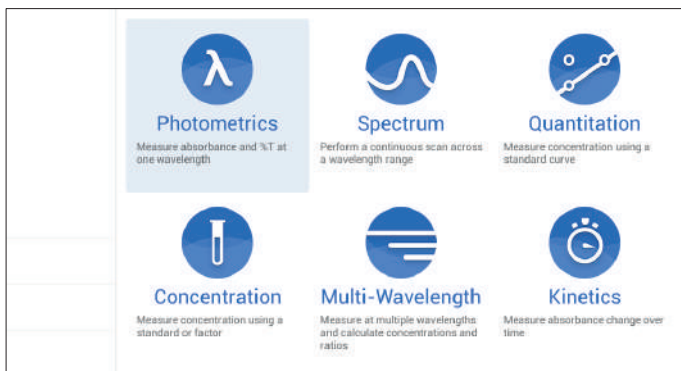

5.1 Method Set up



This measurement mode is very simple and the only parameter which can be adjusted is the wavelength. Once the required wavelength has been entered a calibration can be performed.

5.1.1 Selecting a Wavelength

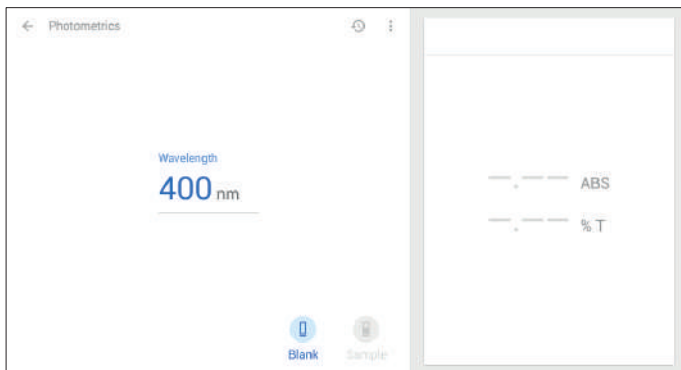
To adjust the wavelength, touch **Wavelength** **400 nm** and use the keypad to enter the required wavelength. Touch **Done** to apply the entered wavelength and return to the method set up.



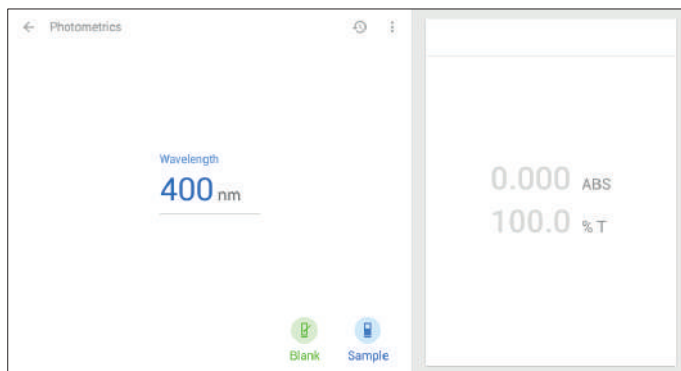

5.2 Calibration

The calibration must be performed at the same wavelength at which the sample will be measured. Insert a cuvette containing the blank solution into the sample chamber and close the instrument lid. Touch the  icon. This sets the instrument to zero absorbance **0.000** ABS and 100% transmittance **100.0** %T. Once the calibration has been performed the  icon becomes active and a sample can be measured.



5.3 Sample Measurement

It is not possible to measure a sample before the instrument has been calibrated at the selected wavelength. Once the calibration has been performed the  icon becomes active and a sample can be measured. Remove the cuvette containing the blank solution and place a cuvette containing the sample to be measured in the sample holder. Close the instrument lid and touch the  icon. Once the measurement is completed the photometric result will be shown on the screen **1.384** ABS **4.1** %T. Subsequent samples can be measured in the same way. If the wavelength is adjusted between sample measurements then the instrument must be calibrated again before more

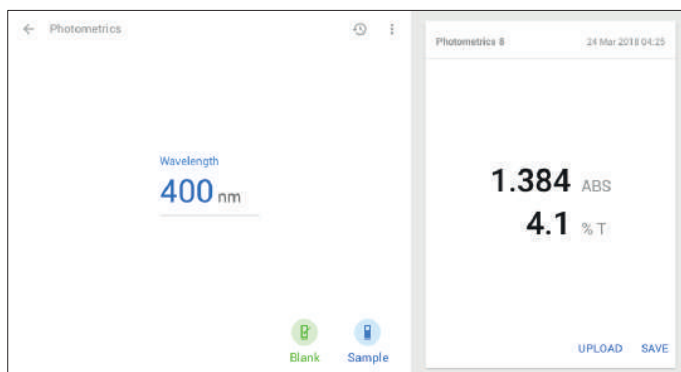

Section 6 - Concentration

The concentration measurement mode enables sample concentrations to be calculated using a standard of a known concentration or a known factor. The sample is measured at one wavelength at one point in time. There are no post measurement calculations available in this measurement mode. Touch the Concentration icon on the main menu to enter this measurement mode.

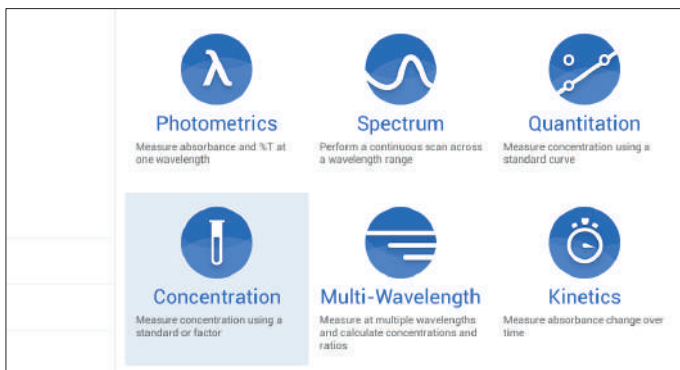

6.1 Method Set up

The parameters which can be entered in this measurement mode are wavelength, factor or standard concentration and units of concentration. Once all the required parameters have been entered a calibration can be performed.

6.1.1 Selecting a Wavelength

To adjust the wavelength, touch ^{Wavelength} 400 nm and use the keypad to enter the required wavelength. Touch **Done** to apply the entered wavelength and return to the method set up.

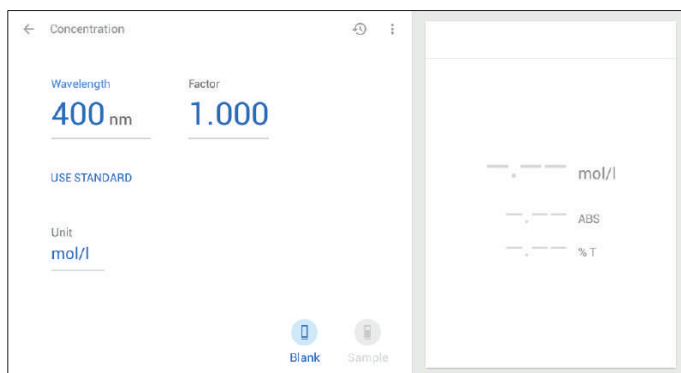

6.1.2 Using a Factor

If the factor is known, there is no need to measure a standard of known concentration. Touch ^{Factor} 1.000 and use the keypad to enter the required factor. Touch **Done** to apply the entered factor and return to the method set up.



6.1.3 Using a Standard

If the factor is not known a standard of known concentration can be measured to calculate concentration. Touch **USE STANDARD** to select this option and disable the use factor option. To enter the concentration of the known standard touch the value under standard 500 mol/l \times and use the keypad to enter the required concentration value. Touch **Done** to apply this concentration and return to the method set up. To return to using a factor touch the \times icon and the use standard option will be disabled.

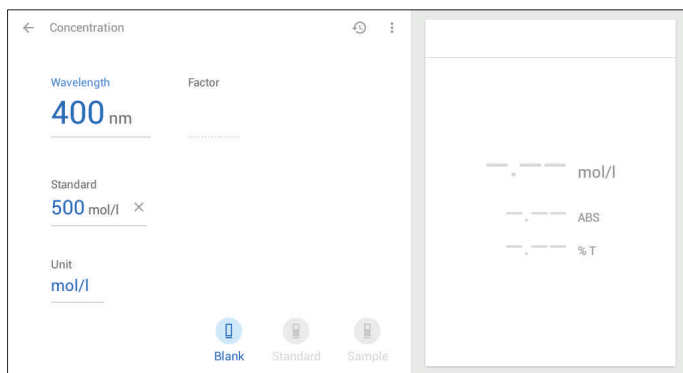

6.1.4 Selecting Concentration Units

The units of concentration can be selected from several options. Touch mol/l to select from the menu. Touch the circle \bigcirc adjacent to the required unit of concentration. The selected unit will be displayed against the final concentration result.

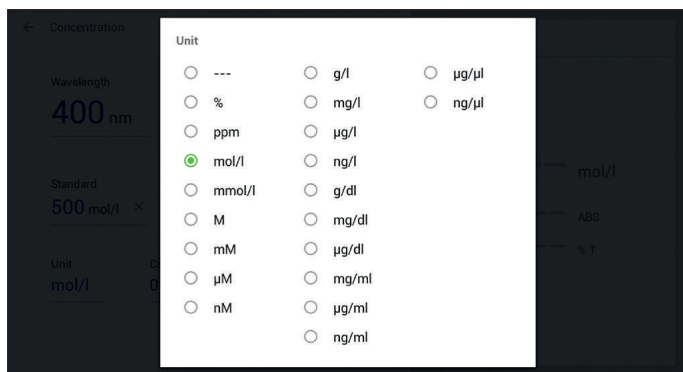

6.2 Calibration



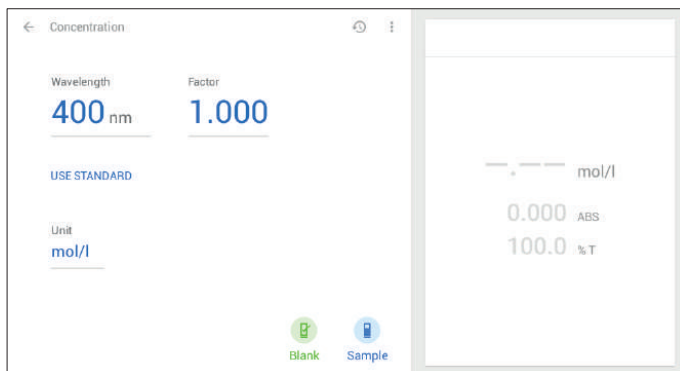

The calibration must be performed at the same wavelength at which the sample will be measured. There are two options depending on if a standard or factor was selected in the method set up.

6.2.1 Calibrating to a Factor

If a Factor has been entered, only a blank calibration is required. Insert a cuvette containing the blank solution into the sample chamber and close the instrument lid. Touch the  icon and the instrument will calibrate to zero absorbance **0.000** ABS and 100% transmittance **100.0** %T. Once the calibration is completed the  icon becomes active and the sample can be measured.



6.2.2 Calibrating to a Standard

Insert a cuvette containing the blank solution into the sample chamber and close the instrument lid. Touch the  icon. This sets the instrument to **0.000** ABS and **100.0** %T. If a standard concentration has been entered the  icon will become active. Insert a cuvette containing the known standard solution into the sample chamber and close the instrument lid. Touch the  icon and the instrument will measure the absorbance of the standard sample. Once the calibration using a standard is complete the unknown sample can be measured and the  icon becomes active.

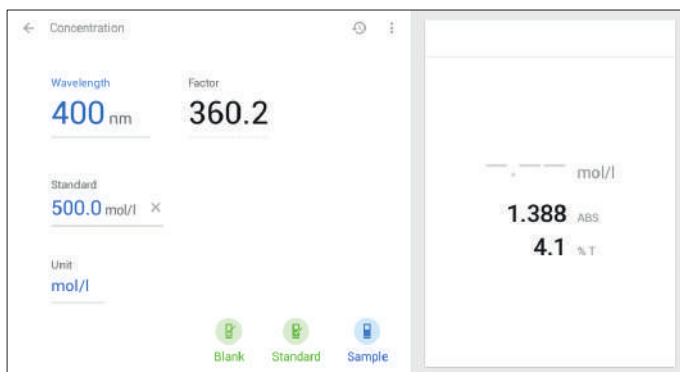

The spectrophotometer will calculate the factor so that this value can be used for future measurements.



6.3 Sample Measurement

It is not possible to perform sample measurements before the instrument has been calibrated at the selected wavelength.

6.3.1 Measuring a Sample After Calibrating to a Factor

Remove the cuvette containing the blank solution and place a cuvette containing the sample to be measured in the sample chamber. Close the instrument lid and touch the  icon. Once the measurement is complete the concentration, absorbance and % transmittance values are displayed

1.385 mol/l
1.385 ABS
4.1 %T

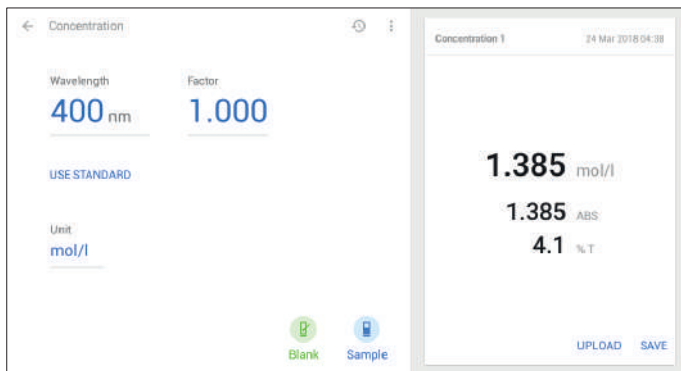

6.3.2 Measuring a Sample After Calibrating to a Standard

Remove the cuvette containing the standard solution and place a cuvette containing the sample to be measured in the sample chamber. Close the instrument lid and touch the  icon. Once the measurement is complete the concentration, absorbance and % transmittance values are displayed

499.2 mol/l
1.386 ABS
4.1 %T

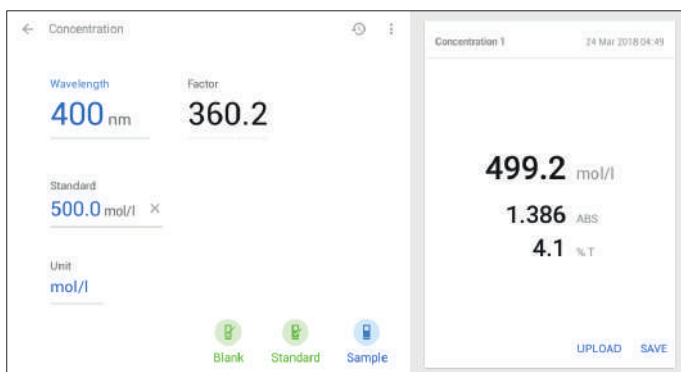

Section 7 - Spectrum

The spectrum measurement mode enables measurements of absorbance or % transmittance over a range of wavelengths to be performed. The absorbance or % transmittance at each wavelength is plotted graphically. Post measurement tools such as peaks and valleys analysis and area under the graph can be performed. This operating mode can be used to partially characterise a sample. Touch the Spectrum icon on the main menu to enter this measurement mode.

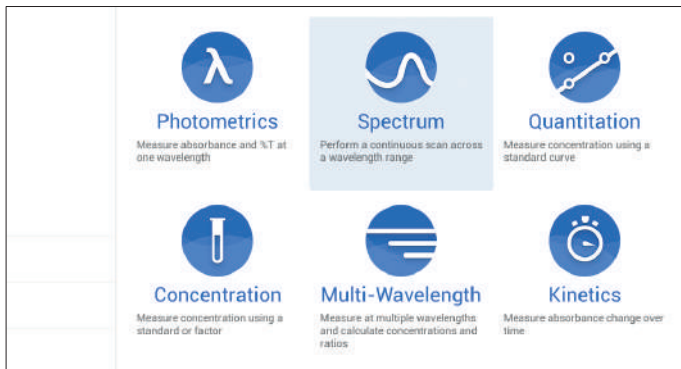

7.1 Method Set up

The parameters which can be entered in this measurement mode are start and end wavelength, scan interval and measurement mode. Once all the required parameters have been entered a calibration can be performed.

7.1.1 Setting Start and End Wavelengths

Model SP-500-VIS can perform measurements from 320nm to 1000nm; model SP-500-UV can perform measurements from 198 to 1000nm. To adjust the start wavelength, touch Start wavelength **400 nm** and use the keypad to enter the required wavelength. Touch **Done** to apply the entered wavelength and return to the method set up. The end wavelength can be adjusted in the same way.



The start and end wavelengths must be different. If the same value is entered an error message will be displayed.



7.1.2 Setting the Scan Interval

This function enables the interval between wavelengths measured in the spectrum scan to be set. The scan interval can be altered to 1, 2, 5 or 10nm by touching the value below scan interval Scan int... **2 nm**. Select the required scan interval from the available options. Touch the adjacent to the required interval to apply. The scan interval can only be selected if the wavelength range is divisible by this number. For example a scan interval of 5nm cannot be selected for a wavelength range of 400 to 503nm.

7.1.3 Selecting Absorbance or % Transmittance

The default operating mode is absorbance. To change this between absorbance or % transmittance, touch Measurement mode **Absorbance (ABS)** or Measurement mode **Transmittance (% T)** to select the required measurement mode. Repeat touches will cycle between the two options.



7.2 Calibration

The calibration must be performed across the same wavelength range as the sample will be measured across. Insert a cuvette containing the blank solution into the sample chamber and close the instrument lid. Touch the  Blank icon to initiate the baseline scan.

This sets the instrument to zero absorbance and 100% transmittance across the wavelength range and scan interval. If the wavelength range or scan interval is changed, a new blank calibration will need to be performed.



7.3 Sample Measurement

It is not possible to measure a sample before a baseline scan has been performed. Once the calibration has been performed the  Sample icon becomes active and a sample can be measured. Remove the cuvette containing the blank solution and place a cuvette containing the sample to be measured in the sample holder. Close the instrument lid and touch the  Sample icon.

Once the scan is complete the spectrum will be shown on the screen.

To perform another spectrum scan using the same method parameters touch **RUN AGAIN**.

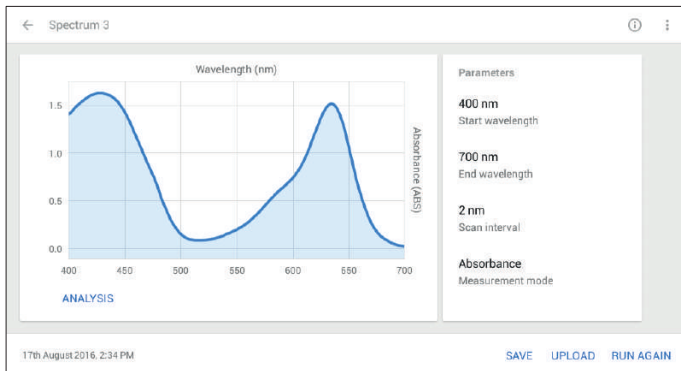

Once the spectrum scan is completed it is possible to analyse the spectrum scan. Post measurement tools include peaks and valleys and area under the curve. To analyse the data touch **ANALYSIS**.

7.4 Data Analysis

Touching the spectrum scan will open a sliding cursor . Slide the cursor across the scan to show the absorbance or %T value at any wavelength.

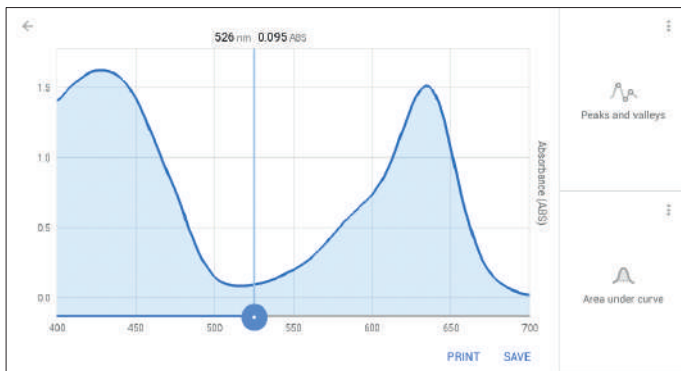

7.4.1 Peaks and Valleys

To view the peaks and valleys touch . The peaks and valleys table displays all the detected peaks and valleys above the selected threshold value.

Touch analysis threshold 0.1 [Analysis Threshold 0.1](#) to change the threshold level. Select the new threshold from the drop down list. [Analysis Threshold 1](#) [Analysis Threshold 5](#) [Analysis Threshold 10](#) [Analysis Threshold 100](#) The graph can be zoomed in and out by pinching two fingers on the screen.

To add a point to the list touch the spectrum scan to open a sliding cursor . Slide the cursor across the scan to the required position or touch the scan. Touch **+ ADD POINT** and the point will be added to the scan and the list.

Touch  to return to data analysis screen and remove any added points.



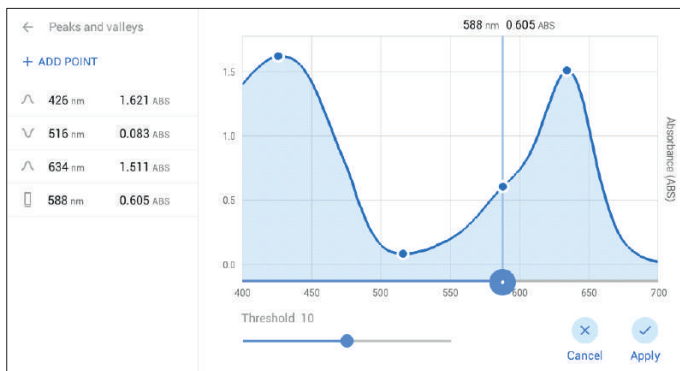



7.4.2 Area Under Curve



To view the area under the curve touch . The default mode is baseline. To change this between baseline and tangent, touch Baseline or Tangent to select the required measurement mode. Repeat touches will cycle between the two options.

7.4.2.1 Area Under Curve - Baseline Mode

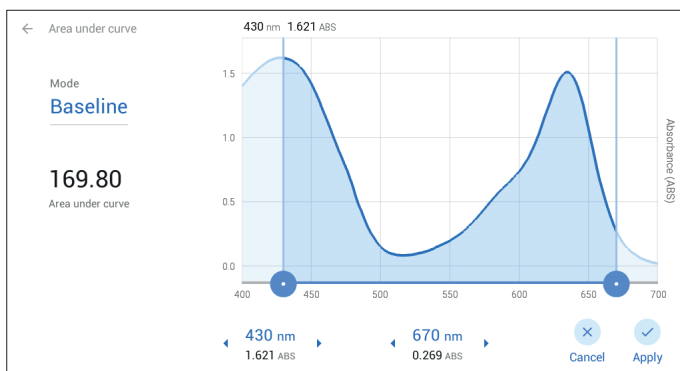
Baseline will calculate the area under the curve between the two sliding cursors . Slide the cursors to the select the area required. You can also use the arrows   to move the selected area.



7.4.2.2 Area Under Curve - Tangent Mode

Tangent will calculate the area under the curve from the point where each of the two sliding cursors  crosses the spectrum scan. Slide the cursors to select the area required. You can also use the arrows   to move the selected area.

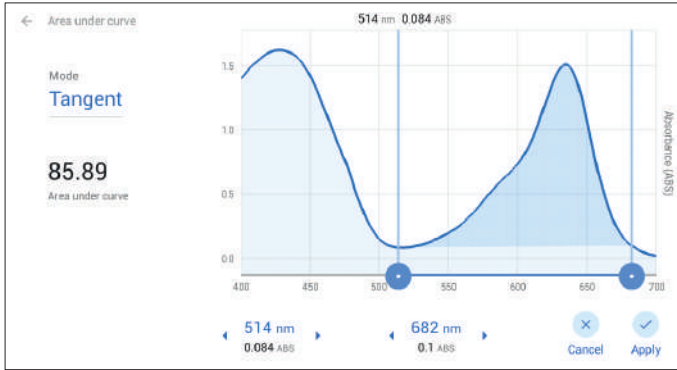

Section 8 - Quantitation

The quantitation measurement mode enables sample concentrations to be calculated using a standard curve. In this mode a number of standard solutions covering a range of known concentrations are measured at a set wavelength. The absorbance or % transmittance of these solutions is plotted to create a standard curve. Once the standard curve has been created a sample of unknown concentration can be measured and the concentration calculated using the standard curve. Touch the Quantitation icon on the main menu to enter this measurement mode.

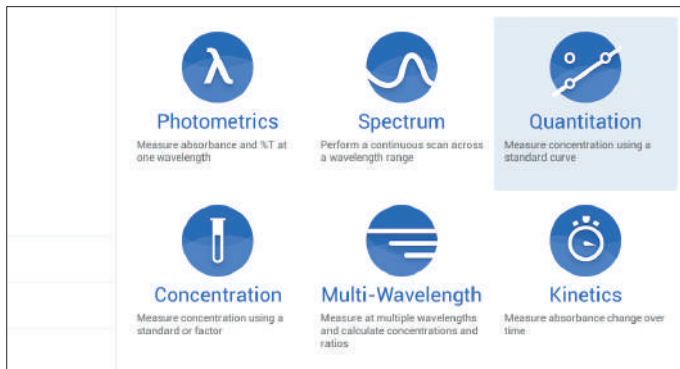

8.1 Method Set up

The parameters which can be entered in this measurement mode are the wavelength, number of replicates for the calibration standards and concentration units of the calibration standards.

8.1.1 Selecting a Wavelength

To adjust the wavelength, touch ^{Wavelength} 400 nm and use the keypad to enter the required wavelength. Touch **Done** to apply the entered wavelength and return to the method set up. The wavelength selected needs to be the same for the measurement of the standards as for the unknown sample.

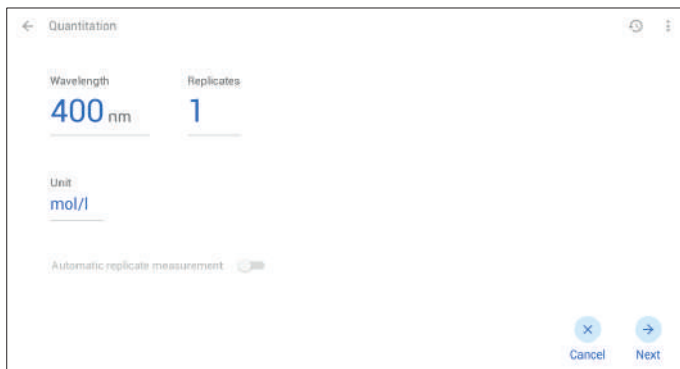

8.1.2 Selecting Number of Replicates

To select the number of repeat measurements of a calibration standard touch **1**. Touch the circle adjacent to the required unit of replicates to apply and return to the method set up.

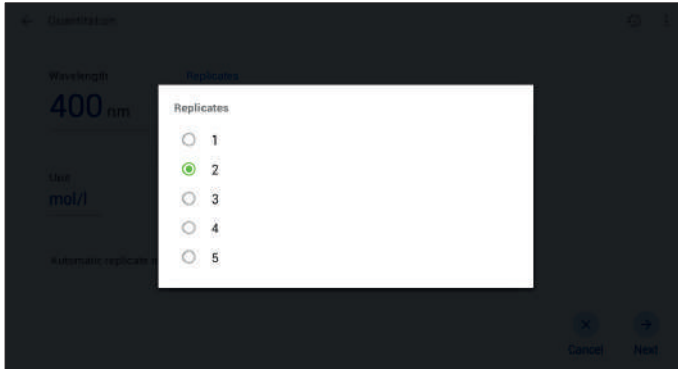

If 2 or more replicates are selected, **Automatic replicate measurement** becomes active. Automatic replicates will read the same sample for the selected number of replicates. If individual sample replicates are being used, do not select the automatic replicates option.

8.1.3 Selecting Concentration Units

The units of concentration can be selected from several options. Touch **mol/l** to select from the menu. Touch the circle adjacent to the required unit of concentration. The selected unit will be displayed against the final concentration result.

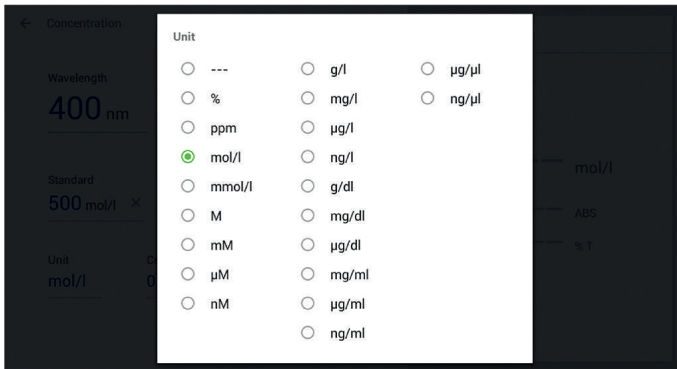

Once the method parameters have been entered touch **Next** to start measuring the calibration standards. Touch **Cancel** to return to the home screen.



8.2 Measuring Calibration Standards

The measured standards are used to create a calibration curve. If there is only one standard available the concentration measurement mode should be used. Touch **ADD STANDARD** to add the first standard.

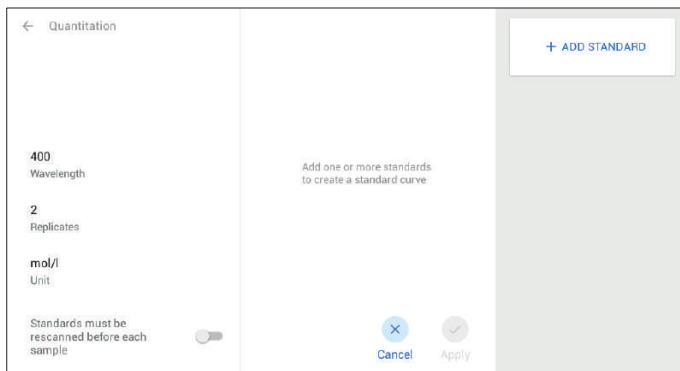

Touch **Concentration** **100 mol/l** to use keypad to enter the concentration value required for that standard. Touch **Done** to apply.

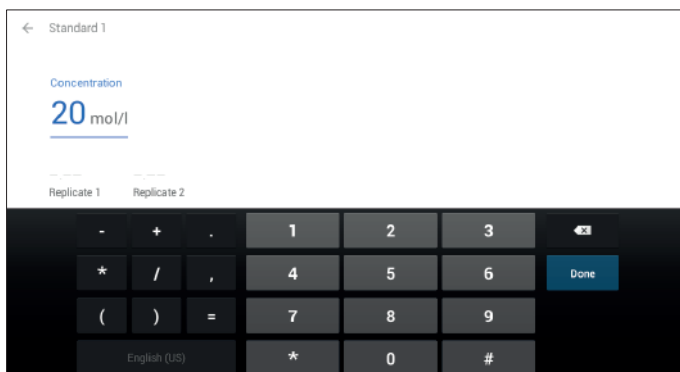



Before the 1st calibration standard is measured a blank sample must be measured first. Insert a cuvette containing the blank into the sample chamber and close the lid. Touch **Blank** to perform a zero absorbance, 100% transmittance. Once the blank is complete remove the blank solution from the sample chamber and place the 1st known standard solution into the sample chamber and close the instrument lid. Touch **Sample** and the instrument will measure the absorbance of the standard sample. If there are 2 or more replicates you will need to touch **Replicate 1**.

Once replicate 1 has been measured, replace it with the next replicate and repeat the process until all replicates have been measured. If using automatic replicate measurement, the same standard will be read for the selected number of times.



Touch  to save the absorbance results for the standard.

Touch **ADD STANDARD** to add another standard and enter the concentration value for that standard. This time a blank is not required so the Standard icon is active straight away. Place the known standard solution into the sample chamber and close the instrument lid. Touch the  icon and the instrument will measure the absorbance of the standard sample. If there are 2 or more replicates you will be asked to measure replicate 1 followed by the remaining replicates.

Touch  to save the absorbance results for the standard.

Repeat the above process for the number of standards required to create the calibration curve.

A calibration curve can be set up in advance and concentrations saved for future use without measuring the absorbance values. When the quantitation assay is next performed, each standard is read to calculate the standard

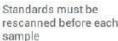
curve. To activate this turn  to on. This can aid in the preparation of frequently used quantitation assays.

8.3 Standard Curve

Following the measurement of each standard the calibration curve is displayed



Specific points can be selected on the graph by touching the graph, a sliding cursor will appear. It is possible to move the cursor by dragging left or right.

The curve fit algorithm can be changed by touching **Linear through zero**. Select between linear through zero, linear, quadratic through zero and quadratic.

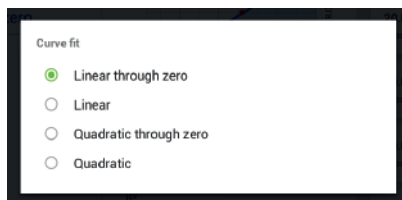

The curve statistics are also displayed for the curve fit chosen. For example if the curve fit is $y = mx + c$ the curve statistics displayed will be the gradient of the line (m), constant (c) and correlation coefficient (r^2).

Once all the standards have been measured touch  and then the unknown samples can be measured.

8.4 Sample Measurement

Place a cuvette containing the sample to be measured in the sample holder. Close the instrument lid and touch the

. Once the measurement is completed the concentration and photometric results will be shown on the screen

58.53 mol/l

0.842 ABS

14.4 %T

. Subsequent samples can be measured in the same way. If the wavelength is adjusted between sample

measurements then the instrument must be calibrated again and a new standard curve must be created before more samples can be measured.

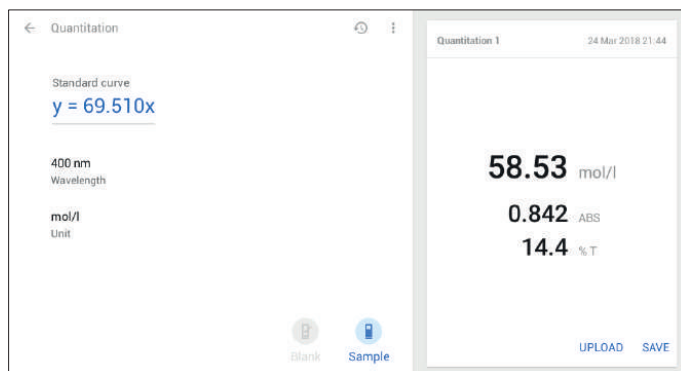

To change the curve fit at any time touch  **Standard curve** $y = 69.510x$ to return to the standard curve screen.

Section 9 - Kinetics

The kinetics measurement mode enables the absorbance or % transmittance of an active molecule to be measured over a set time; for example, enzyme activity. The absorbance or % transmittance is measured at regular time intervals at one wavelength over time. The results are plotted on a graph to show the change in absorbance or % transmittance over time. Following sample measurements analysis of all or part of the experiment can be performed

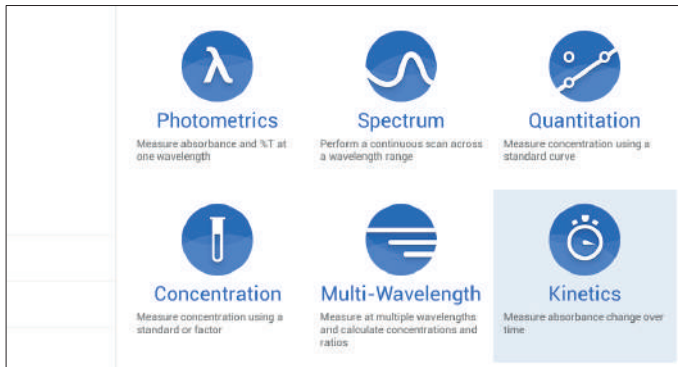

9.1 Method Set up

The parameters which can be entered in this measurement mode are wavelength, run time, measurement time interval, lag time, absorbance or % transmittance measurement mode, and the concentration parameters. Once all the required parameters have been entered a calibration can be performed.

9.1.1 Selecting a Wavelength

The wavelength can be adjusted by touching the wavelength value **400 nm** and using the keypad to enter the required wavelength. Touch **Done** to apply the entered wavelength and return to the method set up.

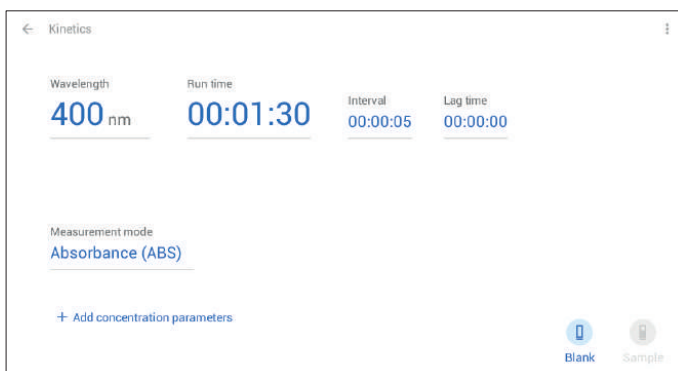

9.1.2 Setting the Kinetics Measurement Time

To set the total kinetics measurement time touch Run time **00:01:30** and enter the required run time. Scroll up or down beneath Hours, Minutes, Seconds to select the required time and touch **OK** to apply. Touch **CANCEL** to exit the run time set up without saving the changes.

9.1.3 Setting the Measurement Time Interval

This is the time that the instrument waits between each measurement during the kinetics run. If it is set to zero then the instrument will perform a measurement at every second during the kinetics run. For example if the run time is 1 hour and the interval is 60 seconds, then the instrument will perform a reading every 60 seconds during the kinetics run.

To set the interval time touch Interval **00:00:05**. Scroll up or down beneath Hours, Minutes, Seconds to select the required time and touch **OK** to apply. Touch **CANCEL** to exit the interval time set up without saving the changes.

NOTE: Minimum interval is 00:00:01

9.1.4 Setting Lag Time

In this measurement mode starting the kinetics measurements can be delayed by setting a lag time. The lag time is the amount of time that the instrument will wait before starting the kinetics measurements after the Sample icon has been touched.

To set the lag time touch Lag time **00:00:00**. Scroll up or down beneath Hours, Minutes, Seconds to select the required time and touch **OK** to apply. Touch **CANCEL** to exit the lag time set up without saving the changes.

9.1.5 Selecting Absorbance or % Transmittance

The default operating mode is absorbance. To change this between absorbance or % transmittance, touch Measurement mode **Absorbance (ABS)** or Measurement mode **Transmittance (% T)** to select the required measurement mode. Repeat touches will cycle between the two options.

9.1.6 End Point Concentration

Following the kinetics run the end point concentration can be calculated using the absorbance value at the end of the kinetics run. Any point can also be selected so that the concentration can be calculated at any time in the kinetics run. A factor is used to calculate concentration.

Touch **+ Add concentration parameters** for access to factor and units. To adjust factor touch Factor **1.000** and use the keypad to enter the required factor. Touch **Done** to apply the entered factor and return to the method set up.

The units of concentration can be selected from several options. Touch Unit **mol/l** to select from the menu. Touch the circle adjacent to the required unit of concentration. The selected unit will be displayed against the final concentration result.

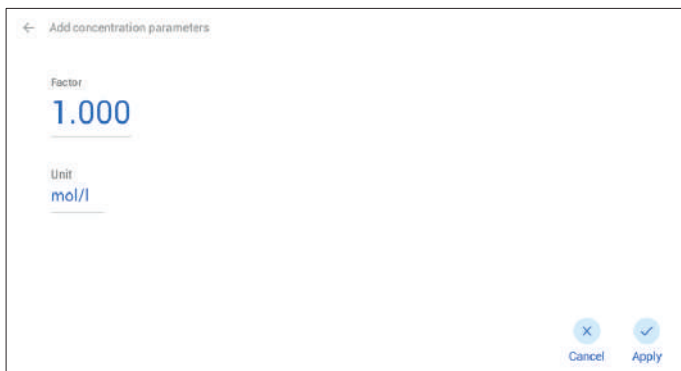

Touch  to apply the concentration parameters and return to method set up.

9.2 Calibration

The calibration must be performed at the same wavelength at which the sample will be measured. Insert a cuvette containing the blank solution into the sample chamber and close the instrument lid. Touch the  icon. This sets the instrument to zero absorbance and 100% transmittance.

9.3 Sample Measurement

It is not possible to measure a sample before the instrument has been calibrated at the selected wavelength. Once the calibration has been performed the Sample icon becomes active and a sample can be measured. Remove the cuvette containing the blank solution and place a cuvette containing the sample to be measured in the sample holder. Close the instrument lid and touch the  icon.

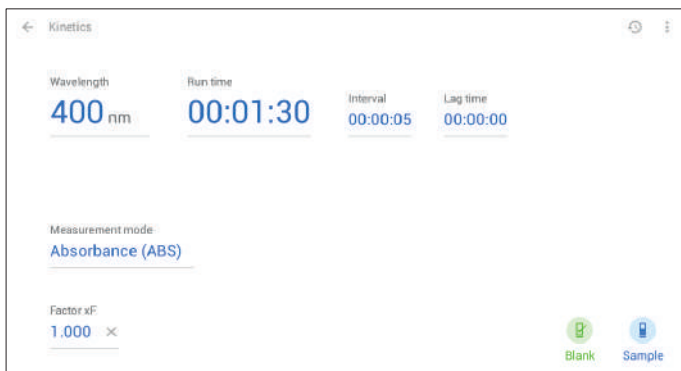

If a lag time has been set the instrument will count down the lag time before the kinetics run starts. If no lag time has been set the kinetics run starts straight away and a live kinetics run is shown on the screen.

If the kinetics run needs to be stopped touch . A warning message will appear asking for confirmation to stop the kinetics run. Touch **OK** to stop the run, touch **CANCEL** to carry on with the kinetic run.

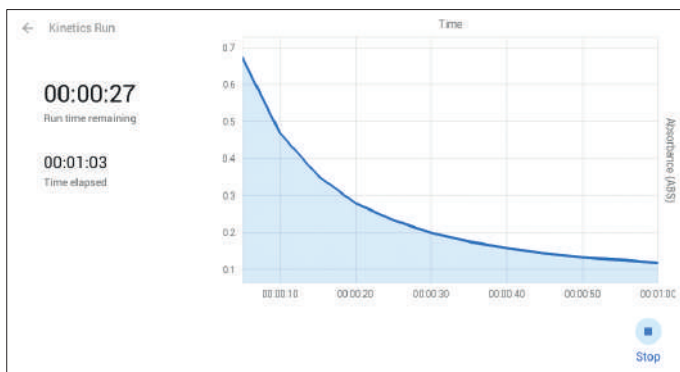

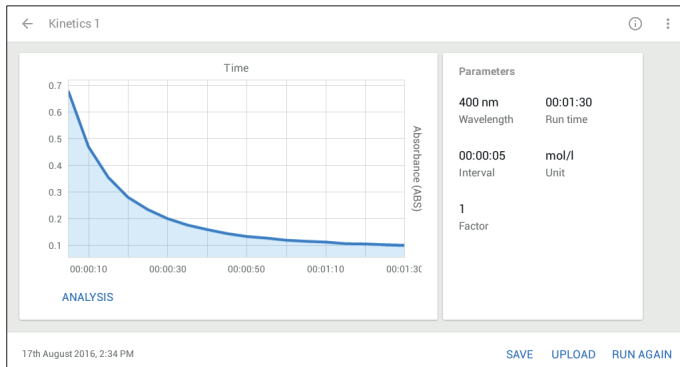

Once the measurement time is complete the full kinetics run will be shown on the screen. To run the kinetics experiment again using the same method parameters touch **RUN AGAIN**. Subsequent samples can be measured in the same way. If the wavelength is adjusted between sample measurements then the instrument must be calibrated again before more samples can be measured.



9.4 Data Analysis

Following the completion of the kinetics measurements it is possible to analyse the data. These include the rate of change and end point concentration. To analyse the data touch **ANALYSIS**.

The rate of change of absorbance over time can be viewed for the entire kinetics run or for selected parts of the kinetics run. Touch  on the graph and slide to the required start or end point in the kinetics run. The rate of change will automatically update. If the end point is moved, this will automatically update the end point concentration.

Alternatively touching   will move the start or end point lines to the required time.

Touch  to return to the results screen.

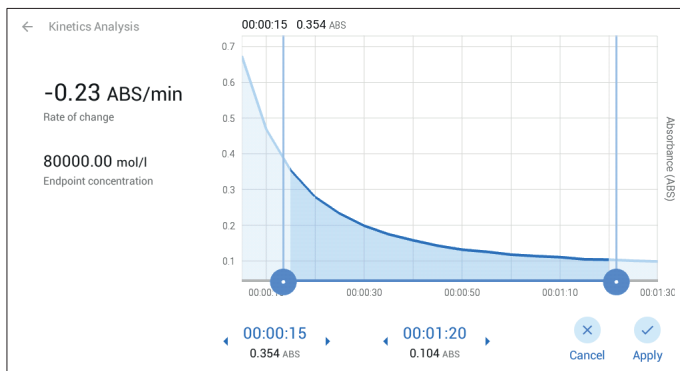

Section 10 - Multi-Wavelength

The multi-wavelength measurement mode enables measurements of absorbance and % transmittance to be performed, as well as concentration and ratios to be calculated. The sample can be measured at four different wavelengths and at one point in time. Touch the Multi-wavelength icon on the main menu to enter this measurement mode.

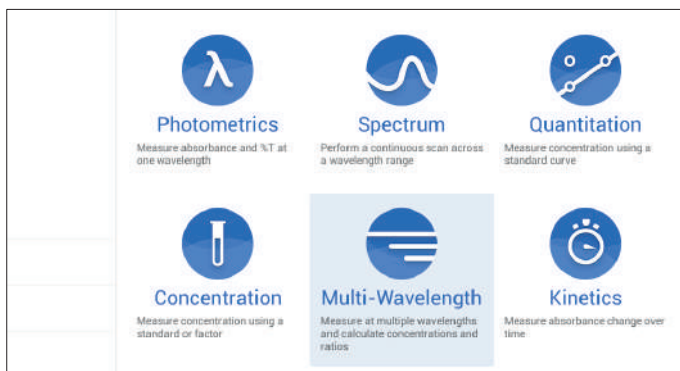

10.1 Method Set up

The parameters which can be entered in this measurement mode are wavelength, type of equation, factor, measurement mode and units of concentration. Once all the required parameters have been entered a calibration can be performed.

10.1.1 Selecting a Wavelength

The wavelength value can be adjusted by touching ^{Wavelength 1 (λ_1)} **400 nm** and then using the keypad to enter the required wavelength. Touch **Done** to apply the entered wavelength and return to the method set up. Two wavelengths are displayed as the default condition. Touch **+ ADD WAVELENGTH** to add an additional wavelength (up to 4). To remove a wavelength touch **× REMOVE** underneath the wavelength value.

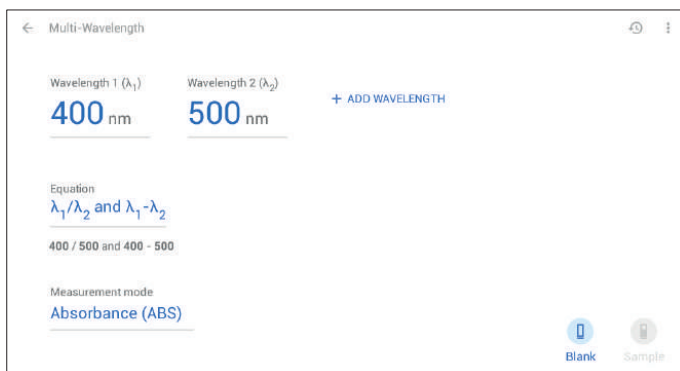

10.1.2 Equation Parameters

To select the required equation parameters, touch the ^{Equation} λ_1/λ_2 and $\lambda_1-\lambda_2$.



The type of equation can be selected from several options. Touch ^{Equation} λ_1/λ_2 and $\lambda_1-\lambda_2$ and select the required equation from the menu.

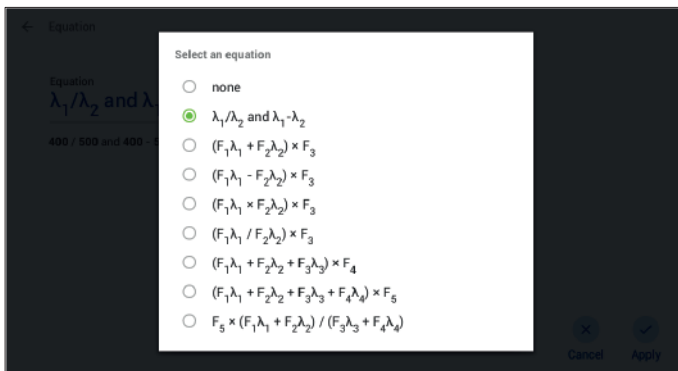

If no equation is selected then the factor and units options will be disabled.

Touch Apply to apply the equation parameters or touch Cancel to return to the method set up without saving any changes.

10.1.2.1 Entering a Factor

If the equation selected requires Factors to calculate the concentration result, the factors will also need to be entered.

Touch ^{Factor F₁} 1.000 and use the keypad to enter the required factor. Touch **Done** to apply the entered factor.

Touch ^{Apply} to apply the factor or touch ^{Cancel} to return to the method set up without saving any changes.

10.1.2.2 Selecting Concentration Units

If the result from the selected equation is a concentration then the units of concentration will also need to be selected. The units of concentration can be selected from several options. Touch ^{Unit} mg/ml to select from the menu.

Touch the circle adjacent to the required unit of concentration. The selected unit will be displayed against the final concentration result.

Touch ^{Apply} to apply the concentration units or touch ^{Cancel} to return to the method set up without saving any changes.

10.1.3 Selecting Absorbance or % Transmittance

The default operating mode is absorbance. To change this between absorbance or % transmittance, touch

^{Measurement mode} Absorbance (ABS) or ^{Measurement mode} Transmittance (%T) to select the required measurement mode. Repeat touches will cycle between



the two options.

10.2 Calibration

The calibration must be performed at the same wavelengths at which the sample will be measured. Insert a cuvette containing the blank solution into the sample chamber and close the instrument lid. Touch the  icon. This sets the instrument to zero absorbance and 100% transmittance.



10.3 Sample Measurement

It is not possible to measure a sample before the instrument has been calibrated at the selected wavelengths. Once the calibration has been performed the  icon becomes active and a sample can be measured. Remove the cuvette containing the blank solution and place a cuvette containing the sample to be measured in the sample holder. Close the instrument lid and touch the  icon. Once the measurement is completed the result will be shown on the screen. Touch **RUN AGAIN** to measure subsequent samples can be measured in the same way. If any of the wavelengths are adjusted between sample measurements then the instrument must be calibrated again before more samples can be measured.

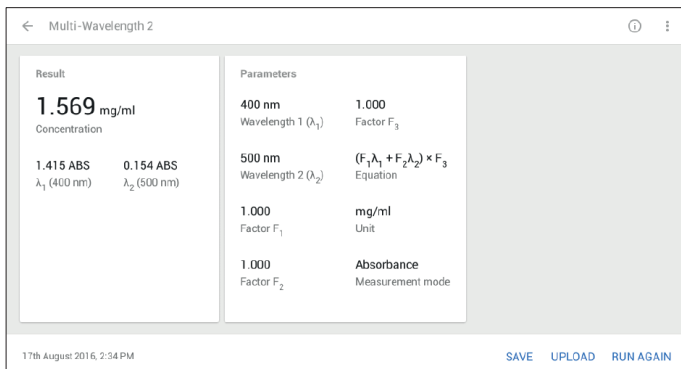



Section 11 - Saving, Loading, Deleting and Printing

11.1 Saving Methods

11.1.1 Saving Methods to Internal Memory





On each method set up screen there is an overflow icon .

Touch  and then touch  Save as Method to save the entered method parameters. Use the keypad to enter the

method name and touch **Save** to apply the name, touch **SAVE**.

11.1.2 Saving Methods to USB Memory Stick

You can save your methods to USB memory stick via the home or method set up screen.

On the home screen touch  Methods. Touch , you can then select each method individually by touching by the side of each method or touch  to select all the methods. Touch the overflow icon  and then touch  Export to USB Drive.

On the method set up screen touch  and then touch  Export to USB Drive to save the entered method parameters.

11.2 Loading Methods





11.2.1 Loading Methods from Internal Memory

On the home screen touch  Methods. Select the required method from the list and touch **RUN** to open.

11.2.2 Loading Methods from USB Memory Stick

This option is currently unavailable.

11.3 Deleting Methods





On the home screen touch  Methods. Touch , you can then select each method individually by touching by the side of each method or touch  to select all the methods. To delete, touch  this will then give you the option to **CANCEL** or **DELETE**.

11.4 Saving Results

11.4.1 Saving Results to Internal Memory

After a measurement has been performed, touch **SAVE**.

11.4.2 Saving Results to USB Memory Stick

On the home screen touch  Results. Touch , you can then select each method individually by touching by the side of each method or touch  to select all the methods. Touch the overflow icon  and then touch  Export to USB Drive.

11.5 Loading Results





11.5.1 Loading Results from Internal Memory

On the home screen touch  Results. Touch the required result from the list to view information.

11.5.2 Loading Results from USB Memory Stick

This option is currently unavailable.

11.6 Deleting Results

On the home screen touch  Results. Touch , you can then select each result individually by touching by the side of each result or touch  to select all the results. To delete, touch  this will then give you the option to **CANCEL** or **DELETE**.

11.7 Printing

Results can be printed by connecting the optional printer SMP50/PRINTER to one of the type A USB ports (ref. 2.3 Overview) on the front of the spectrophotometer. Following completion of a result, the option to print will be displayed. Touch **PRINT** to print the results.

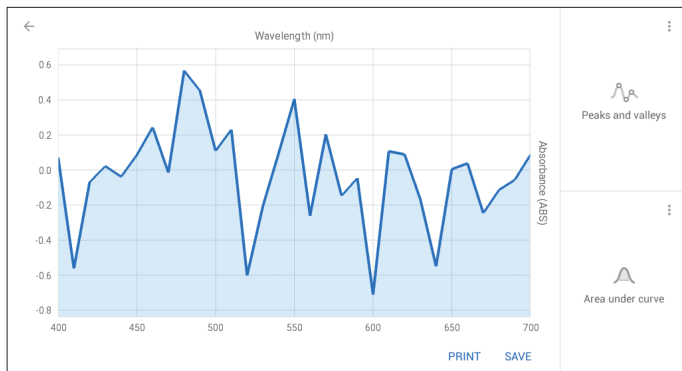

Results shown as an example only.

Section 12 - Accessories and Spare Parts

12.1 Optional Accessories

Please visit www.Cole-Parmer.com for a full list of available accessories.

12.2 Installing the Accessories



WARNING: Before installing any accessories, ensure that the equipment is cool, and disconnect from the power supply

There are two types of accessories which can be fitted in the sample chamber – passive (non-powered) or active (powered) accessories. The range of passive accessories includes 10 x 10mm single cuvette holders, adjustable path length (10 to 100 mm) cuvette holders, test tube holders and micro-cuvette holders. The active accessories include an automated 8 cell changer.

12.2.1 Passive Accessories

Unscrew the thumb screw to undo the passive accessory. Lift out the passive accessory. To fit a different passive accessory simply place the accessory in the correct orientation, align the thumb screw and tighten to fix in place.

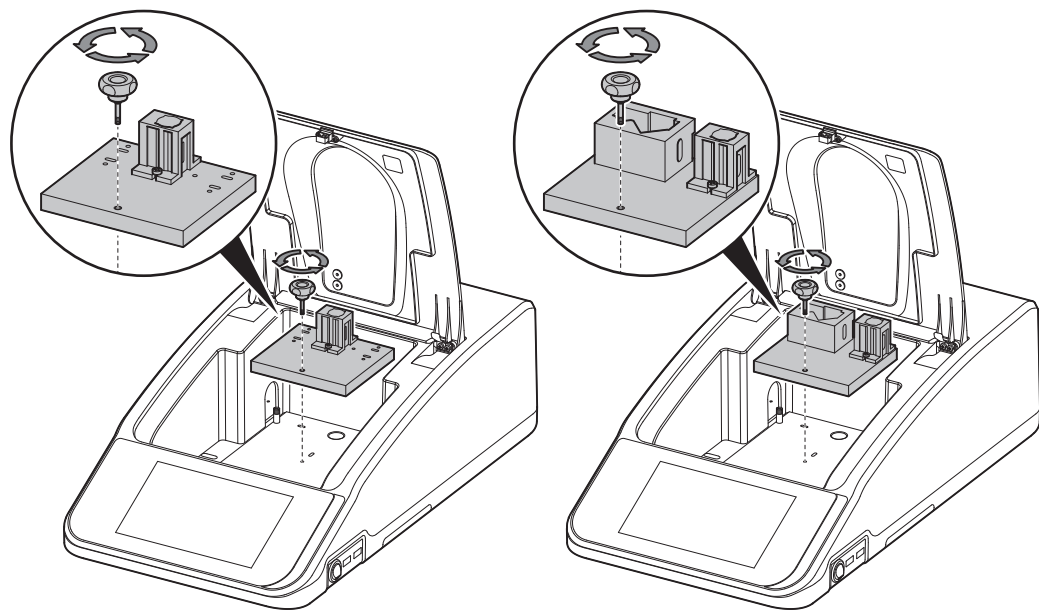

12.2.2 Active Accessories

Unscrew the thumb screw to undo the passive accessory. Lift out the passive accessory. Unscrew the screws **1** to **4** and lift out the metal base panel.

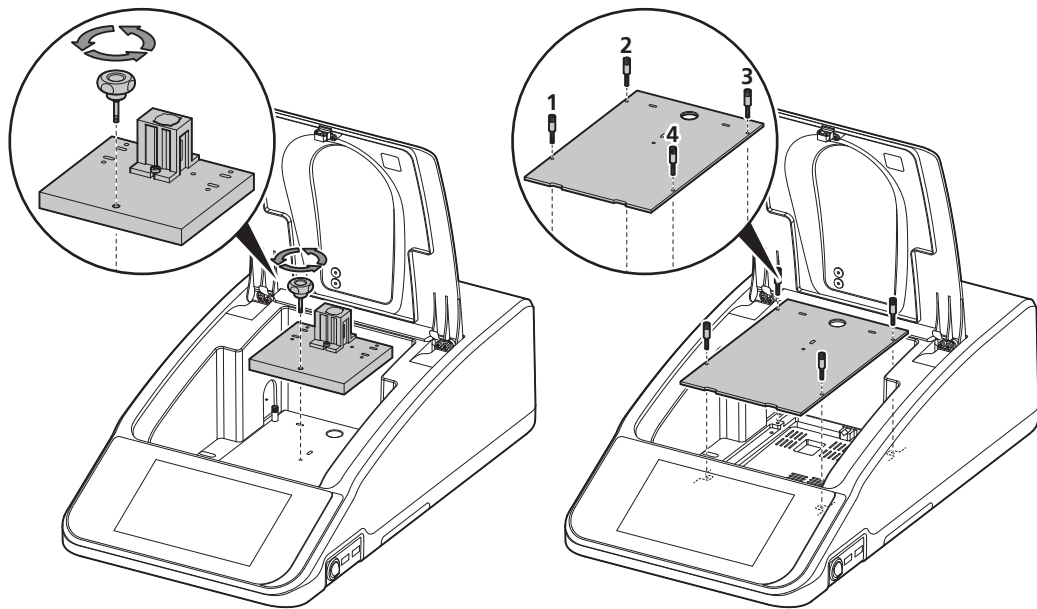

This will expose the bottom of the sample chamber and the power supply connection needed to operate the active accessories.

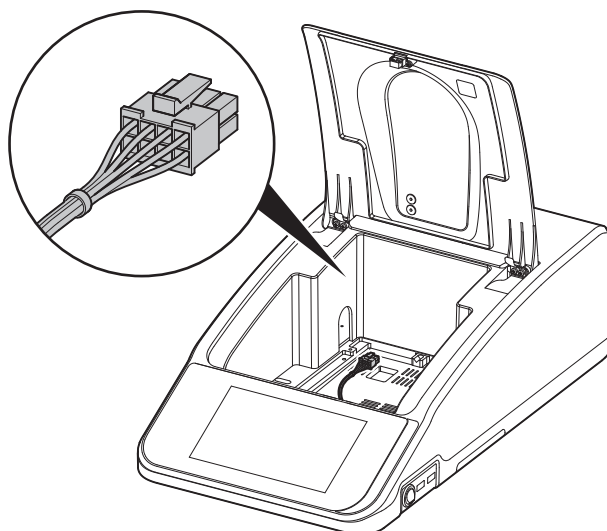

12.2.2.1 Installing Automatic 8 Cell Turret

Take the 8 cell turret base plate. Connect the power supply in the bottom of the sample chamber to the connector in the underside of the base plate. Place the base plate in the sample chamber. Replace screws **1** to **4**.

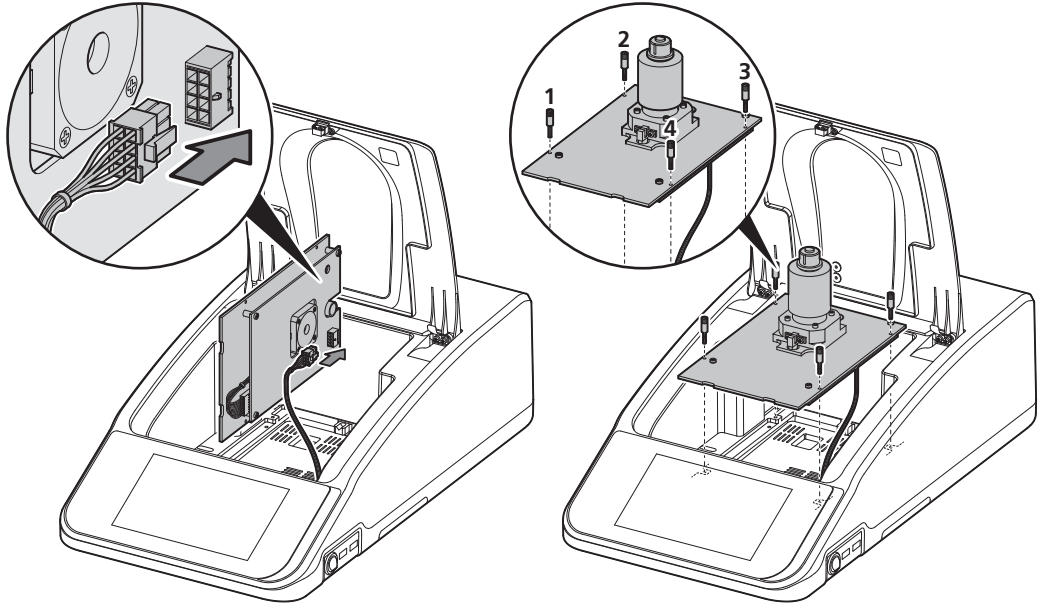

Take the 8 cell carousel and place on top of the motor, taking care to align the three ball bearings with the grooves on the motor shaft. Gently push the carousel down onto the motor shaft until it is located into place. Gently rotate the carousel until there is some resistance. The carousel is now in the correct position.

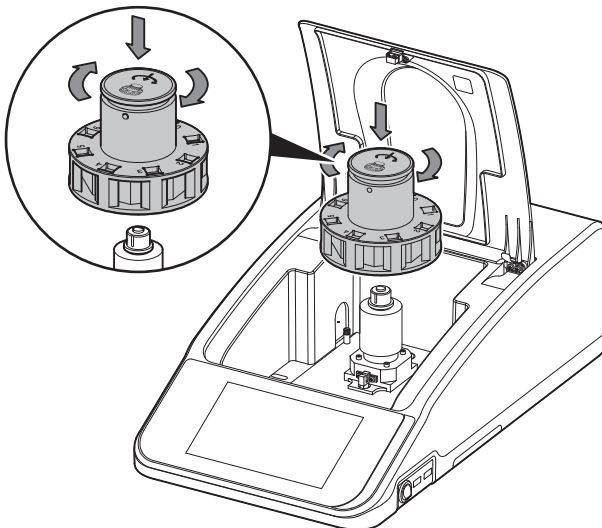

If the fitting is too tight use a small screw driver to loosen the ball bearings before pushing the carousel down onto the shaft.

12.3 Using the Accessories



12.3.1 Automatic 8 Cell Turret

When the automatic 8 cell turret is installed the active accessory  icon is displayed on the home or measurement method set up screen.

The automatic 8 cell turret can be used in either a manual or automatic mode. To select mode, touch  on the home or measurement method set up screen. Touch  to switch between each mode. Touch  to return.

12.3.1.1 Automatic 8 Cell Turret - Manual Mode

Set to manual mode. Select the measurement mode you require (photometrics has been used as an example only), the automatic 8 cell turret will automatically move to position 0. The current cell position will be displayed .

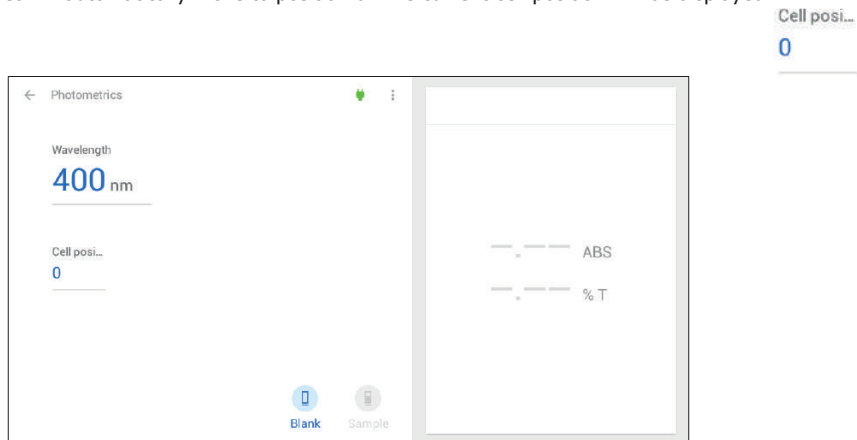

Set up the required measurement parameters. Insert the cuvette containing the blank solution into turret position 0 followed by the cuvettes containing the samples into turret positions 1 to 7 and close the instrument lid.



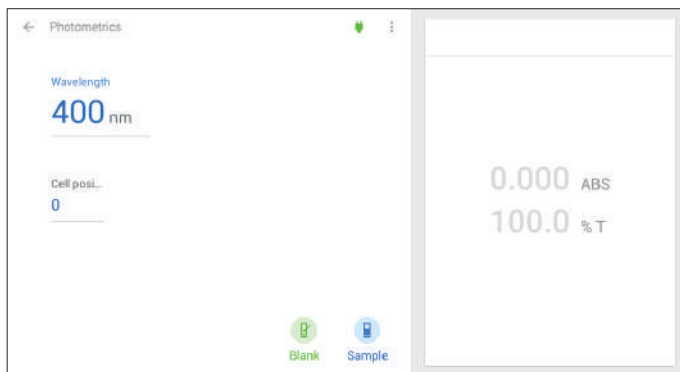

Note: Before starting measurement ensure cell position  is set to 0.

Touch  and the instrument will set to zero absorbance  and 100% transmittance 

Once the calibration has been performed the  becomes active and samples can be measured.



The turret will need to move to take its next measurement. To do this touch **0** to change the cell position.

You can also change the cell position by touching  and then selecting the required position . Touch  to return to the method set up screen and touch  to measure the sample.

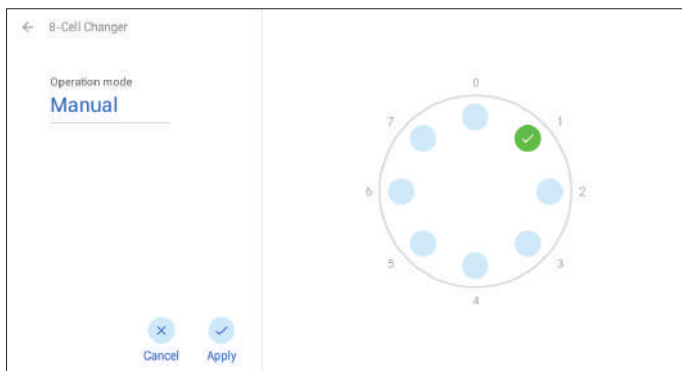

Repeat the process until all the samples have been measured.

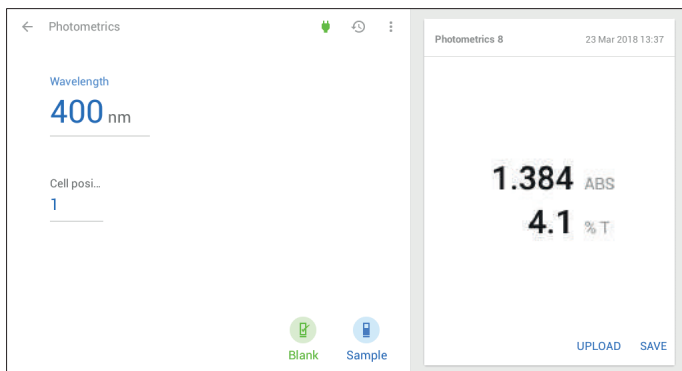

Once the measurement is complete the result will be shown. At this point you can either **SAVE** or **UPLOAD**.

12.3.1.2 Automatic 8 Cell Turret - Automatic Mode

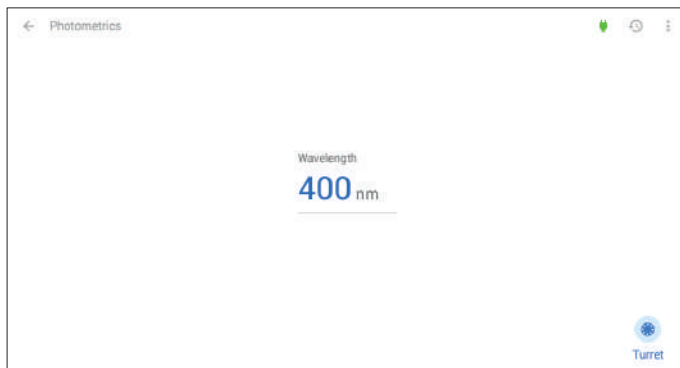

Set to automatic mode. Select the measurement mode you require (photometrics has been used as an example only), the automatic 8 cell turret will automatically move to position 0.





Set up the required measurement parameters. Insert the cuvette containing the blank solution into turret position 0 followed by the cuvettes containing the samples into turret positions 1 to 7 and close the instrument lid.

Touch  and then touch  twice at position 1. This will activate the sample icon .

Touch  once at each of the positions you have inserted samples into. This will activate the sample icon .

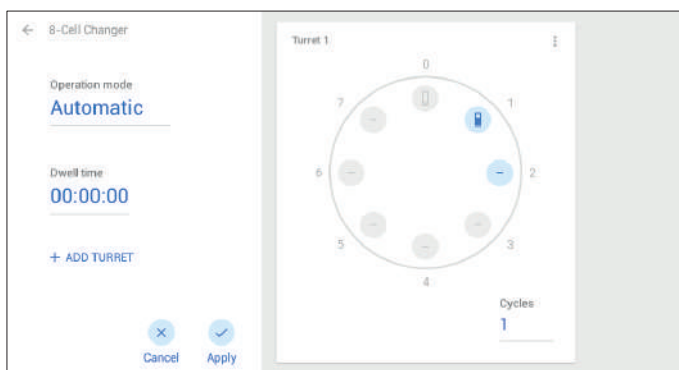
Touch  to apply changes and return to method set up or touch  to return to method set up without saving any changes.



Touch  and the instrument will automatically set the instrument to zero absorbance and 100% transmittance. Once the calibration has been performed the turret will automatically measure each sample.

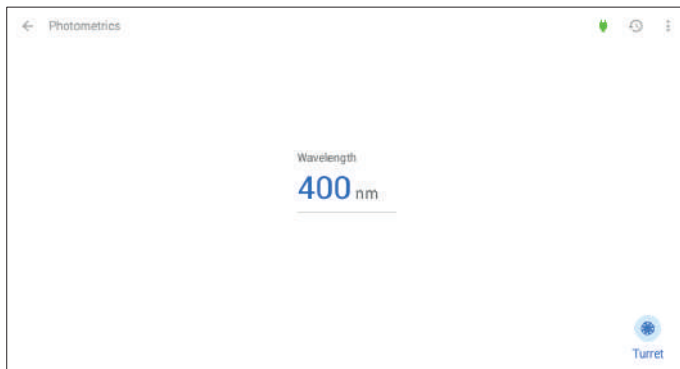

Once all of the samples have been measured the results will be displayed. Touch the corresponding cell position  1 1.384 ABS to view the results.

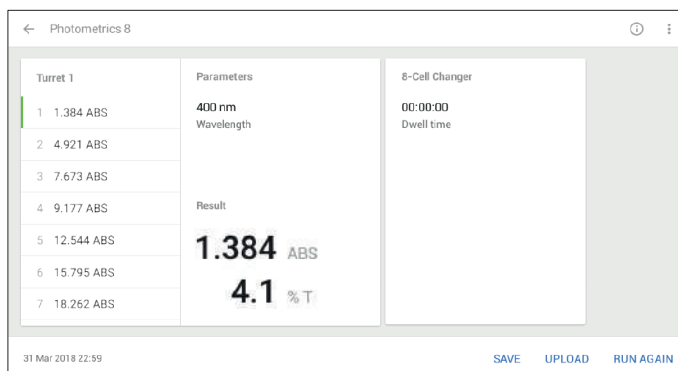

At this point you will be able to [SAVE](#) , [UPLOAD](#) or [RUN AGAIN](#) .

12.3.1.3 Automatic 8 Cell Turret - Supporting Creation of a Standard Curve in Quantitation

This option is currently unavailable.

12.4 Spare Parts

Please contact your local sales specialist or email cpspares@antylia.com to enquire about available spares.

Section 13 - Maintenance, Servicing and Cleaning



WARNING: Before attempting any maintenance, servicing or cleaning, ensure that the equipment has been allowed to cool down.



WARNING: Ensure the equipment is disconnected from the power supply before attempting any maintenance, servicing or cleaning.



WARNING: Do not work within the equipment while the lamp is ON as exposure to the high intensity light can cause injury to your eyes.

13.1 Routine Maintenance

Ensure the external surfaces of the unit are clean and free from dust. The sample area should always be kept clean and any accidental spillage should be wiped away immediately. To give added protection when not in use, the equipment should be disconnected from the mains supply and covered with the optional dust cover.

If the equipment needs to be cleaned ensure the equipment is switched off and disconnected from the mains supply before cleaning. Wipe down the unit with a soft damp cloth and a mild detergent solution. Do not use bleach or abrasives. Do not allow cleaning liquids to ingress inside the equipment. Never immerse the unit, cables or plugs in water or any other liquids. Allow any wet surfaces to dry before re-connecting to the mains supply and commencing use.

The only routine maintenance which maybe required is the replacement of the light source. The replacement lamps are available from your local distributor (refer to section 12.4 for part codes). Only genuine replacement lamps should be used. Similar lamps may have different filament configurations or be wavelength restricted for domestic or commercial use and will give errors if used.



WARNING: This product does not contain bio-seals as per EN61010-1-2010 and cannot provide any level of containment in case of a spill or release of toxic, radioactive, or pathogenic micro-organisms thus these materials are not recommended to be used in this product.

NOTE: Do not use solvents for cleaning any parts of this equipment.

In Case of Accidental Spillage



WARNING: Do not touch if a spillage/breakage has occurred. Disconnect the power directly at the power supply source.

If any part of the unit has been exposed to liquid, it cannot be assumed to meet all the safety requirements of EN61010-1-2010 until the drying out process has been fully completed and all safety requirements are met before the unit is used again.

In Case of Contamination



WARNING: The following procedure is intended as a guide. Should spillage of a toxic or hazardous fluid occur, then additional special precautions may be necessary.

If the equipment has been exposed to contamination, the Responsible Body is responsible for carrying out appropriate decontamination. If hazardous material has been spilt on or inside the equipment, decontamination should only be undertaken under the control of the Responsible Body with due recognition of possible hazards. Before using any cleaning or decontamination method, the Responsible Body should check with the manufacturer that the proposed method will not damage the equipment. Prior to further use, the Responsible Body shall check the electrical safety of the unit. Only if all safety requirements are met can the unit be used again.

NOTE: In the event of this equipment or any part of the unit becoming damaged or requiring service, the item(s) should be returned to the manufacturer for repair accompanied by a decontamination certificate. Copies of the Certificate are available from the Distributor/Manufacturer.

At the end of its service life, the product must be accompanied by a Decontamination Certificate.

13.2 Lamp Replacement

13.2.1 Tungsten Halogen Lamp Replacement

This option is only valid for the SP-500-VIS Spectrophotometers. We recommend the equipment is turned onto its side to allow easy access to the lamp holder cover located on the underneath of the equipment (refer to section 2.3). Wear 'lint free' protective gloves when replacing the lamp to prevent marking the lamp with finger prints.

- I. Remove the screws and lamp holder cover.
- II. Disconnect the electrical connector.
- III. Remove the two fixing screws and washers which retain the lamp assembly.
- IV. Grab the two tabs on the plastic lamp assembly and remove the whole lamp assembly, this may need to be rotated slightly to allow it to be removed.

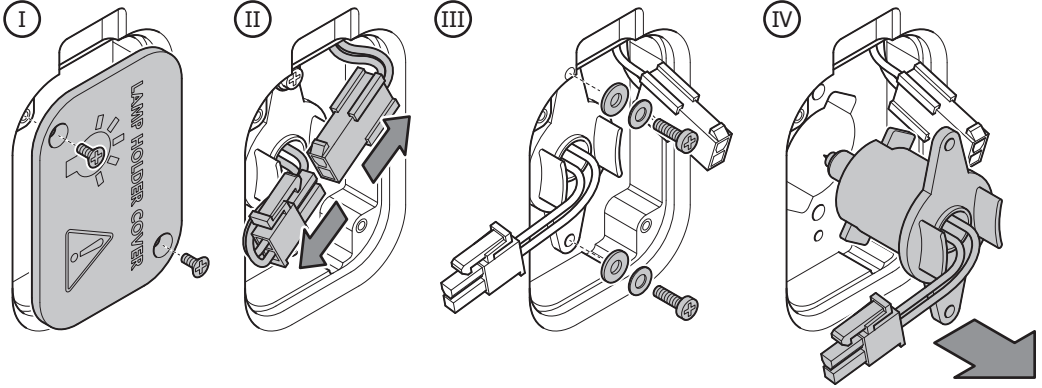

- V. Carefully remove the replacement lamp from the packaging. Ensure that the glass portion of the lamp is not touched as finger marks will damage the lamp resulting in a reduced performance. If accidental damage occurs the surface of the lamp may be cleaned using propan-2-ol.
- VI. Insert the new lamp assembly into the same position as the one just removed. This may need to be rotated slightly to be fully inserted. Ensure that the fixing studs on the plastic lamp assembly line up with the fixing holes in the unit.
- VII. Replace the two screws and washers removed earlier back in position to fully secure the lamp assembly. It must be fully pulled against the black aluminium fixing plate.
- VIII. Reconnect the electrical connector.
- IX. Replace the screws and lamp holder cover ensuring no wires are trapped.

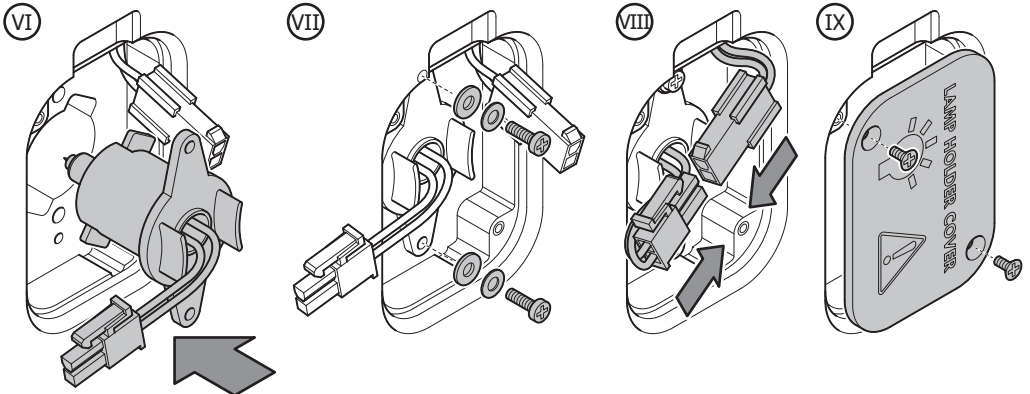

- X. Place the equipment back in its correct orientation.
- XI. Reconnect the power supply, turn the equipment on and allow to self-calibrate with the new lamp.

For further instructions refer to the service manual.

13.2.2 Xenon Lamp Module Replacement

This option is only valid for the SP-500-UV Spectrophotometers and must only be done by an accredited service engineer (refer to section 13.3).

13.3 Service, Repairs and Support

Any service, repairs or replacement of parts MUST be undertaken by suitably qualified personnel. Only spare parts supplied or specified by Cole-Parmer or its agents should be used. Fitting of non-approved parts may affect the performance and safety features designed into the instrument. For a comprehensive list of parts required by service engineers conducting internal repairs please contact the service department quoting the model and serial number:

Email: cpSERVICE@antylia.com

Tel: +44 (0)1785 810475

For technical support enquiries please contact;

Email: cpTECHSUPPORT@antylia.com

Tel: +44 (0)1785 810433

13.4 Warranty

Cole-Parmer Ltd. warrants this instrument to be free from defects in material and workmanship, when used under normal laboratory conditions, for a period of 3 years. This includes the Xenon lamp used in the SP-500-UV but excludes the Tungsten lamp used in the SP-500-VIS which is covered by a 1 year warranty. In the event of a justified claim Cole-Parmer will replace any defective component or replace the unit free of charge. This warranty does NOT apply if damage is caused by fire, accident, misuse, neglect, incorrect adjustment or repair, damage caused by incorrect installation, adaptation, modification, fitting of non-approved parts or repair by unauthorised personnel.

Antylia Scientific Ltd,
Beacon Road,
Stone,
Staffordshire,
ST15 0SA,
United Kingdom

Email: cpSERVICE@antylia.com

Tel: +44 (0)1785 810475

Web: www.Cole-Parmer.com

Section 14 - Environmental Protection

14.1 Packaging Material



Packaging materials have been carefully selected so they can be sorted for recycling.

14.2 Waste Electrical and Electronic Equipment Directive (WEEE)



At the end of your product and accessories life, it must not be discarded as domestic waste. Ref: EU Directive 2012/19/EU on Waste Electrical and Electronic Equipment Directive (WEEE). Please contact your distributor / supplier for further information. For end users outside of the EU consult applicable regulations.

Section 15 - Technical Specifications

15.1 General Specification SP-500-VIS/SP-500-UV/SP-600-UV

	SP-500-VIS	SP-500-UV	SP-600-UV
Wavelength Range (nm)	320 to 1000	198 to 1000	198 to 1000
Wavelength Step (nm)	1.0	1.0	0.1
Wavelength Accuracy (nm)	± 2	± 2	± 1
Wavelength Reproducibility (nm)	± 0.5	± 0.5	± 0.2
Spectral bandwidth (nm)	5.0	5.0	1.5
Absorbance Range (Abs)	- 0.300 to 2.500	- 0.300 to 2.500	- 0.300 to 3.000
Absorbance Accuracy (Abs)	± 0.01 Abs at 1.000Abs	± 0.01 Abs at 1.000Abs	± 0.01 Abs at 1.000Abs at 546 nm and 257 nm
Stray light	<0.5% at 340nm	<0.5% at 340nm and 220nm	<0.5% at 340nm and 220nm
Stability	<0.002 Abs/hr after 30 minute warm up	<0.001 Abs/hr without warm up	<0.001 Abs/hr at 0.050Abs and 546 nm
Noise			± 0.01 Abs at 0.050 Abs at 546 nm ± 0.02 Abs at 2.000 Abs at 546 nm
Accessories	Automatic 8 cell turret Peltier 10 mm cell Single 10 x 10 cuvette holder 15 mm micro cuvette holder 8.5 mm micro cuvette holder Adjustable cuvette holder 10 x 10 up to 10 x 100 mm 16/24 test tube holder Film holder External printer Dust cover		
USB for data storage	USB A for USB memory sticks		
Printer Connection	USB external printer		
Chemical Resistance	100% Ethanol, 1% Bleach, 100% Isopropanol, 2% Neutracon, 50% Methanol, Water		
Supply Voltage and Power Requirements	100-240V at 50 or 60 Hz, 70W		
Weight	<7.5 kg		
Warranty	3 years but excluding the Tungsten lamp which has 1 year warranty	3 years including the Xenon lamp	2 years, extended to 3 years with customer registration
Operating Temperature °C	15 °C to 35 °C		
Safe Operation	5 °C to 40 °C		
Max. Relative Humidity	0 to 80% for temperatures up to 31 °C, decreasing linearly to 50% at 40 °C		
Ambient for Testing °C	20.0 °C ± 2.0 °C		
Maximum Altitude (m)	2000		
Pollution Degree	2		
Noise Output (dBA)	<43		

15.2 Weights and Dimensions

Weight 9.0kg

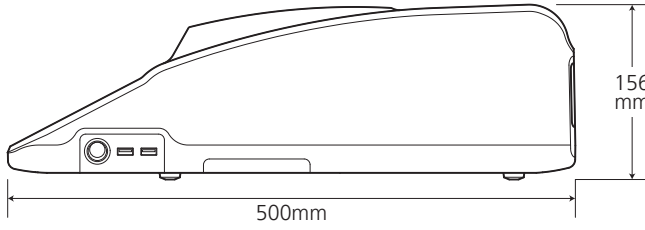
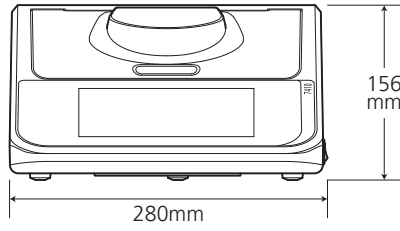

Section 16 - Troubleshooting

During initial power on self-test (POST)

The following errors can appear during the initial self-test.

A hardware problem has been detected. You may continue to use the instrument but calibration data may have been affected causing any readings to be inaccurate. Contact Cole-Parmer support and quote error code 101.

A hardware problem has been detected. Contact Cole-Parmer support and quote error code 102.

A potential hardware problem has been detected. If the lid is currently open, close it and try again. If it's currently closed, contact Cole-Parmer support and quote error code 103.

A hardware problem has been detected. Contact Cole-Parmer support and quote error code 104.

A hardware problem has been detected. Contact Cole-Parmer support and quote error code 105.

A hardware problem has been detected. Contact Cole-Parmer support and quote error code 106.

A hardware problem has been detected. Contact Cole-Parmer support and quote error code 107.

A potential hardware problem has been detected. If there's currently a sample in the instrument, remove it and try again. If there's no sample in the instrument, contact Cole-Parmer support and quote error code 108.

A potential hardware problem has been detected. If there's currently a sample in the instrument, remove it and try again. If there's no sample in the instrument, contact Cole-Parmer support and quote error code 109.

A potential hardware problem has been detected with the fitted microvolume accessory. Contact Cole-Parmer support and quote error code 110.

A potential hardware problem has been detected with the fitted cell changer accessory. Contact Cole-Parmer support and quote error code 111.

During scanning (blank, standard or sample)

The following errors can appear whenever the optical hardware is used. Each error message will be attached to the activity which was just performed.

The error messages are displayed as a notification on screen with an option to display more information about the error. If multiple errors have been detected, they will be displayed in the more information.

The 'blank / standard / sample' failed due to a potential hardware fault

A fault has been found whilst taking the reading. If an accessory is connected, check the cable is firmly connected and turn the instrument on and off again before trying again. If this continues to occur contact Cole-Parmer support and quote error message 112.

The 'blank / standard / sample' failed due to a potential hardware fault

A fault has been found whilst taking the reading. If an accessory is connected, check the cable is firmly connected and turn the instrument on and off again before trying again. If this continues to occur contact Cole-Parmer support and quote error message 113.

The 'blank / standard / sample' failed because the lamp has been disabled due to being too warm

The instrument has disabled the lamp because the unit is too warm. Check the air vents for any obstructions which may be interrupting airflow, and turn the unit off to allow it to cool down. If this continues to occur contact Cole-Parmer support and quote error message 114.

The 'blank / standard / sample' failed because a potential hardware fault detected with the fan

The fan has dropped below its normal operating speed. Check the air vents for any obstructions which may be interrupting airflow, and then turn the instrument off and on again before trying again. If this continues to occur contact Cole-Parmer support and quote error message 115.

The 'blank / standard / sample' failed due to potential hardware fault

Turn the instrument on and off again and try again. If this continues to occur, contact Cole-Parmer support and quote error message 116.

The 'blank / standard / sample' failed because the lamp is too hot

Check the air vents for any obstructions which may be interrupting airflow and turn the unit off to allow it to cool down. If this continues to occur, contact Cole-Parmer support and quote error message 117.

The following warning messages will be displayed next to results when detected. They are indicated by an icon, which when pushed will display a dialog containing the warning information.

Lamp warm up warning

The lamp is still warming up. This can take up to 30 minutes after turning the instrument on, or after entering lamp safe mode. Readings taken during this time may be inaccurate.

Calibration data lost warning

This reading may be inaccurate as a hardware problem has affected calibration data.

Section 17 - Glossary of Icons



Sample warning



Cancel



Save



Analysis
Area under curve



Unused turret position



Search



Analysis
Peaks and valleys



Delete



Settings



Concentration



Select all



Spectrum peak



Kinetics



Deselect favourite



Spectrum valley



Multi-wavelength



Favourite



Standard complete



Photometrics



Load method



Stop



Quantitation



Save as method



Results



Spectrum



Measurement Settings



Turret



Back arrow



Clear recent



Export to USB



Blank



Information



Hide favourites panel



Blank complete



Overflow



Network connections



Apply



Accessory attached



Service settings



Select files



Printer



Take reading

Index

A

Accessories and Spare Parts.....	47
Active Accessories.....	48
Automatic 8 Cell Turret.....	50
Automatic 8 Cell Turret - Automatic Mode.....	52
Automatic 8 Cell Turret - Manual Mode.....	50
Supporting Creation of a Standard Curve in Quantitation.....	54

B

Beer-Lambert law.....	10
-----------------------	----

C

Concentration.....	22
Calibrating to a Factor.....	24
Calibrating to a Standard.....	24
Calibration.....	23
Measuring a Sample After Calibrating to a Factor.....	25
Measuring a Sample After Calibrating to a Standard.....	25
Method Set up.....	22
Sample Measurement.....	25
Selecting a Wavelength.....	22
Selecting Concentration Units.....	23
Using a Factor.....	22
Using a Standard.....	23

D

Deleting Methods.....	45
Deleting Results.....	46

E

Electrical Requirements.....	7
Environmental Protection.....	58

G

General Description.....	6
General Specification.....	59
Glass cuvettes.....	12
Good Practice Guidelines.....	12

I

Important Safety Advice.....	6
In Case of Accidental Spillage.....	55
In Case of Contamination.....	55
Installation.....	8
Installation Conditions.....	8
Installing Automatic 8 Cell Turret.....	49
Installing the Accessories.....	47
Instrument Language.....	16
Instrument Set up.....	14

Instrument Status.....	16
Introduction.....	6

K

Kinetics.....	36
Calibration.....	38
Data Analysis.....	40
End Point Concentration.....	37
Method Set up.....	36
Sample Measurement.....	38
Selecting Absorbance or % Transmittance.....	37
Selecting a Wavelength.....	36
Setting Lag Time.....	37
Setting the Kinetics Measurement Time.....	37
Setting the Measurement Time Interval.....	37

L

Lamp Replacement.....	57
Loading Methods.....	45
Loading Methods from Internal Memory.....	45
Loading Methods from USB Memory Stick.....	45
Loading Results.....	46
Loading Results from Internal Memory.....	46
Loading Results from USB Memory Stick.....	46

M

Maintenance, Servicing and Cleaning.....	55
Main View.....	9
Measurement Settings.....	18
Methods.....	16
Multi-Wavelength.....	41
Calibration.....	44
Entering a Factor.....	43
Equation Parameters.....	42
Method Set up.....	41
Sample Measurement.....	44
Selecting Absorbance or % Transmittance.....	43
Selecting a Wavelength.....	41
Selecting Concentration Units.....	43

N

Navigation.....	14
Network Connections.....	19

O

Optional Accessories.....	47
Overview.....	9

P	
Packaging Material	58
Passive Accessories	47
Photometrics.....	20
Calibration	21
Method Set up	20
Sample Measurement	21
Selecting a Wavelength.....	20
Plastic disposable cuvettes	12
Printing	46
Q	
Quantitation.....	31
Measuring Calibration Standards.....	33
Method Set up	31
Sample Measurement	35
Selecting a Wavelength.....	31
Selecting Concentration Units.....	32
Selecting Number of Replicates	32
Standard Curve	34
R	
Rear View	9
Results	16
Routine Maintenance	55
S	
Saving, Loading, Deleting and Printing	45
Saving Methods.....	45
Saving Methods to Internal Memory	45
Saving Methods to USB Memory Stick.....	45
Saving Results.....	46
Saving Results to Internal Memory	46
Saving Results to USB Memory Stick.....	46
Service, Repairs and Support	58
Service Settings	19
Settings.....	16
Setting the Date.....	17
Setting the Time	17
Setting the Time Zone	18
Spare Parts	54
Spectroscopy Measurement.....	11
Spectrum.....	26
Area Under Curve.....	29
Area Under Curve - Baseline Mode	29
Area Under Curve - Tangent Mode.....	30
Calibration	27
Data Analysis	28
Method Set up	26
Peaks and Valleys.....	28
Sample Measurement	27
Selecting Absorbance or % Transmittance.....	27
Setting Start and End Wavelengths.....	26
Setting the Scan Interval	27
Storage	19
Symbols Defined	6
T	
Technical Specification	59
Theory and Practice of Spectroscopy Measurement.....	10
Theory of Spectroscopy Measurement.....	10
Tungsten Halogen Lamp Replacement	57
U	
Underneath View.....	9
Unpacking	8
Using the Accessories	50
W	
Warranty	58
Waste Electrical and Electronic Equipment Directive (WEEE)	58
Weights and Dimensions.....	60
X	
Xenon Lamp Module Replacement	58

Declaration of Conformity

 This product meets the applicable CE Directives and UKCA Legislation for radio frequency interference and may be expected not to interfere with, or be affected by, other equipment with similar qualifications. We cannot be sure that other equipment used in its vicinity will meet these standards and so we cannot guarantee

that interference will not occur in practise. Where there is a possibility that injury, damage or loss might occur if equipment malfunctions due to radio frequency interference, or for general advise before use, contact the manufacturer.

Declaration of Conformity is available to view online at www.coleparmer.com

EU Representative address

Cole-Parmer Ltd
Bâtiment le Deltaparc Icade
Paris Nord 2
7 rue du Canal
BP 55437 Villepinte
95944 ROISSY Charles de Gaulle
France
Tel: +33 (0) 1 48 63 78 00
Email: frsales@antylia.com

UK Representative address

Antylia Scientific
9 Orion Court
Ambuscade Road
Colmworth Business Park
St. Neots
PE19 8YX
United Kingdom

Ordering Information

Order No.	Cole-Parmer Series	Cole-Parmer Model	Jenway Model	Jenway Part No.
83056-21	SP-500	SP-500-VIS	7410 Visible Spectrophotometer	741001
83056-22	SP-500	SP-500-UV	7415 UV/Visible Spectrophotometer	741501
83056-26	SP-600	SP-600-UV	7615 UV/Visible Spectrophotometer	761501

Warranty Registration



UK

T: +44 (0) 1480 272279
 E: uk.sales@antylia.com
 W: coleparmer.co.uk

Germany

T: +49 (0) 9377 92030
 E: de.sales@antylia.com
 W: coleparmer.de

France

T: +33 (0) 1486 37800
 E: fr.sales@antylia.com
 W: coleparmer.fr

Italy

T: +39 (0) 284349215
 E: it.sales@antylia.com
 W: coleparmer.com

India

T: +9122 61394444
 E: info@coleparmer.in
 W: coleparmer.in

China

T: +1 847 549 7600
 E: sales@antylia.com
 W: coleparmer.com

USA

T: +1 847 549 7600
 E: sales@antylia.com
 W: coleparmer.com

Canada

T: +514 355 6100
 E: info@antylia.ca
 W: coleparmer.ca

Other

T: +1 847 549 7600

Cole-Parmer®

Antylia Scientific Ltd.
 Beacon Road,
 Stone,
 Staffordshire,
 ST15 0SA,
 United Kingdom

